

3 611 B58 300  
Issue  
Stand ) 11-09-14

**Fig./Abb. 2**

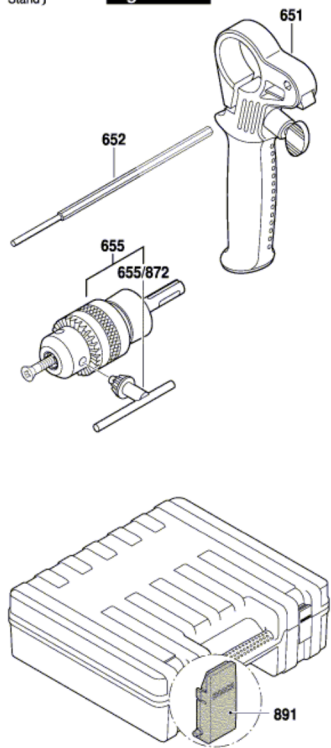

Modifications reserved  
Änderungen vorbehalten  
Modifications réservées  
Salvo modificaciones