

3 611 B50 500

Issue } 14-06-23
Stand }

Fig./Abb. 2

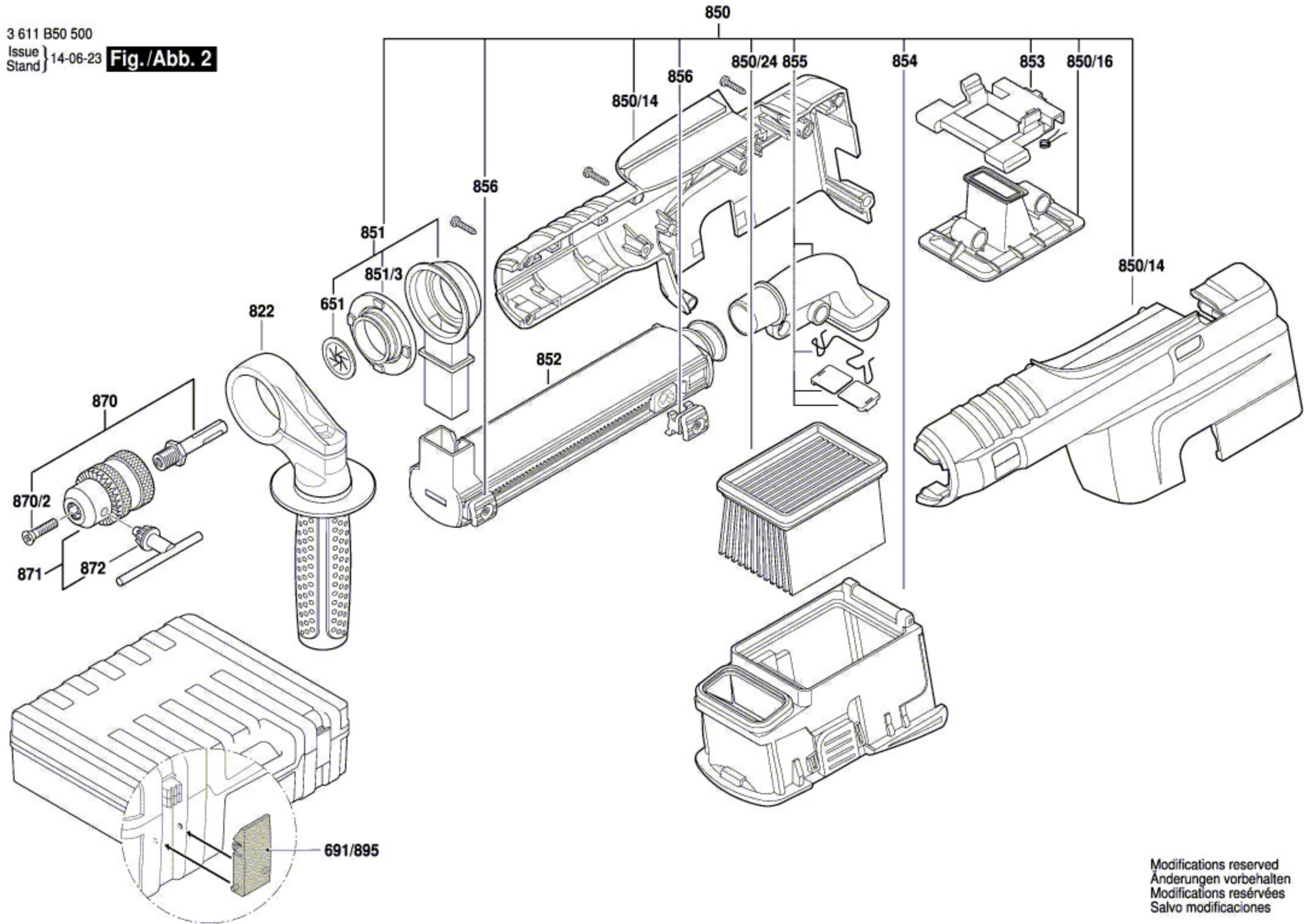

Modifications reserved
Änderungen vorbehalten
Modifications réservées
Salvo modificaciones