

3 600 H76 D00
Stand } 04-09
Issue } 04-12-17

Fig./Abb. 2

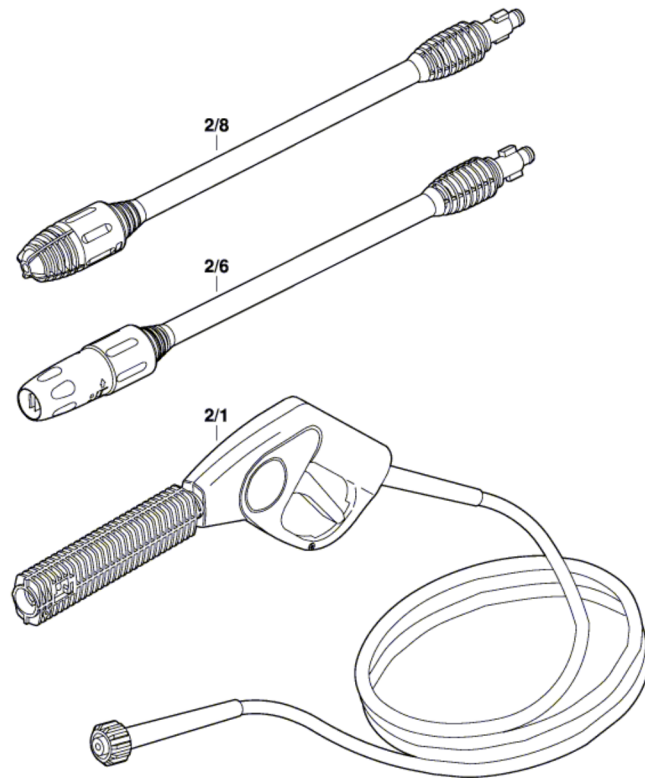

Änderungen vorbehalten
Modifications reserved
Modifications réservées
Salvo modificaciones