

Fig. 02

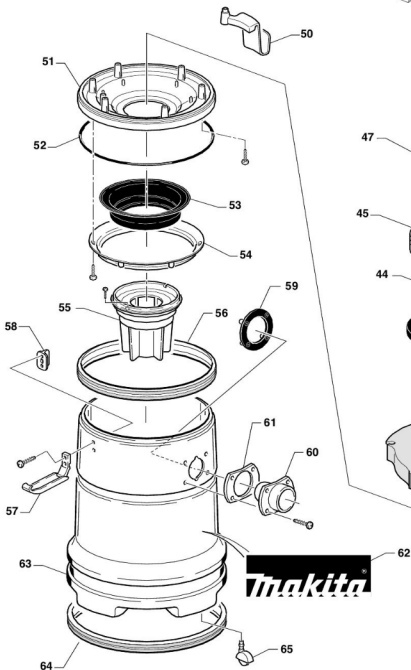

Fig. 1

