

3 601 K63 200
Stand } 13-07
Issue } 14-02-27

Fig./Abb. 1

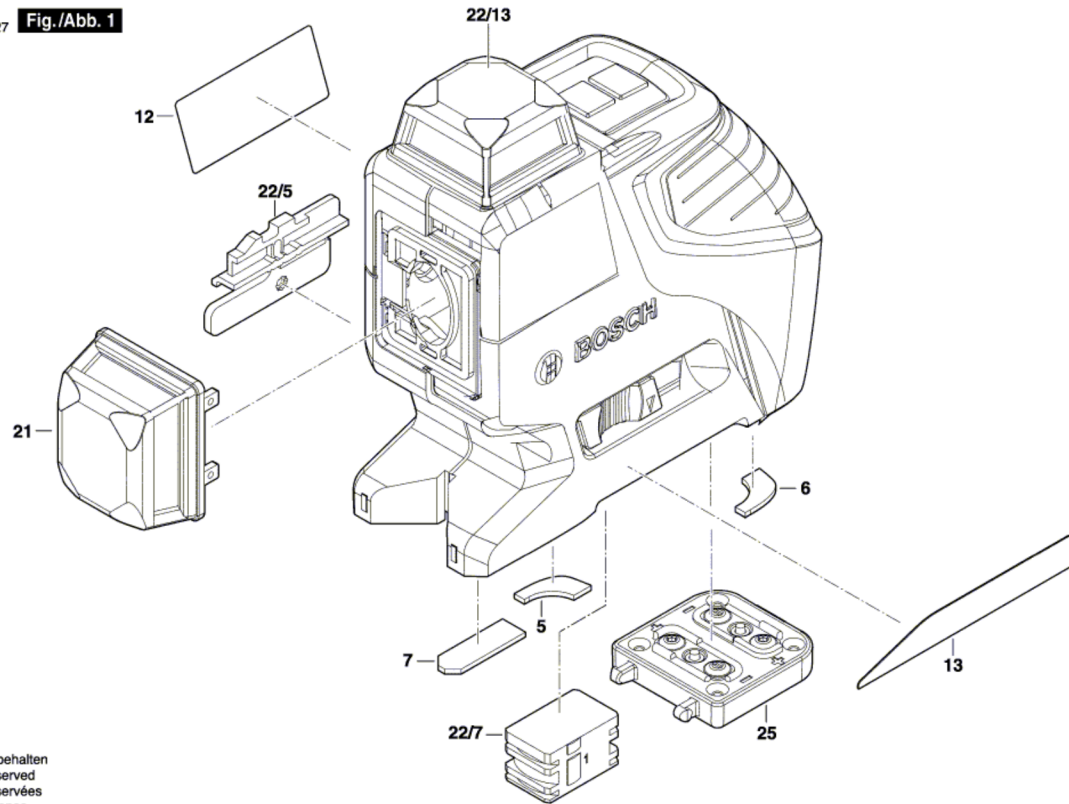

Änderungen vorbehalten
Modifications reserved
Modifications réservées
Salvo modificaciones