

3 601 G95 200

Stand } 12-07-26 **Fig./Abb. 2**
Issue }

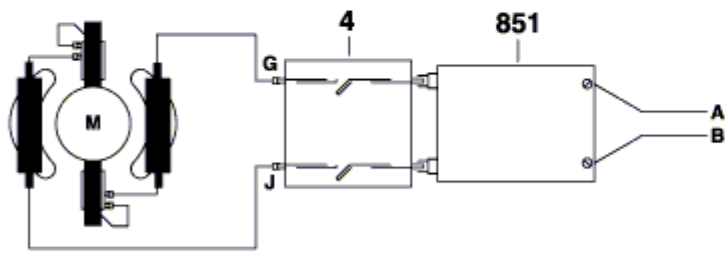
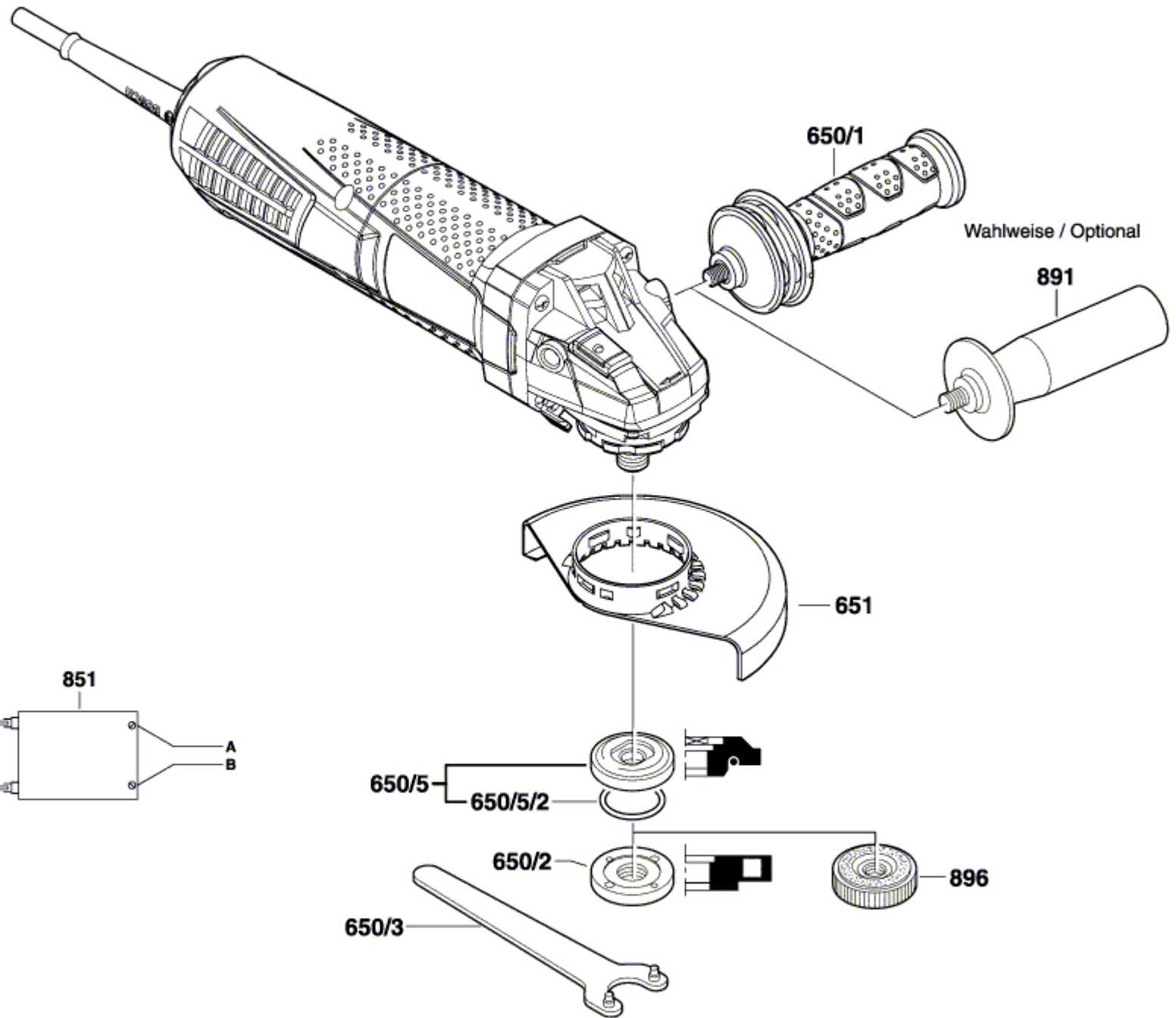

Änderungen vorbehalten
Modifications reserved
Modifications reserves
Salvo modificaciones