

0 601 854 003 - 065
Stand } 01-09
Issue } 08-01-17 **Fig. /Abb. 2**

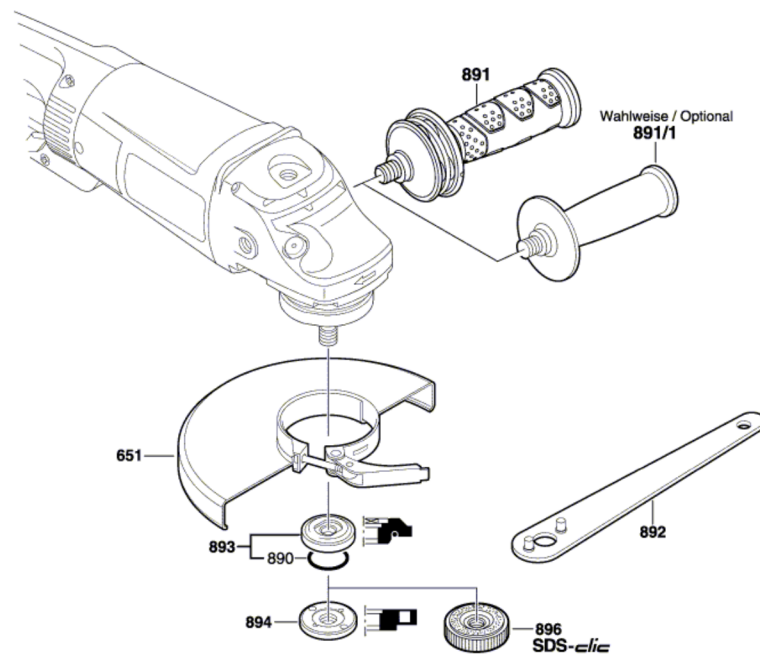

Änderungen vorbehalten
Modifications reserved
Modificaciones reserves
Salvo modificaciones