

F 015 900 401

Stand } 05-07-19
Issue } 05-07-20

Fig./Abb. 1

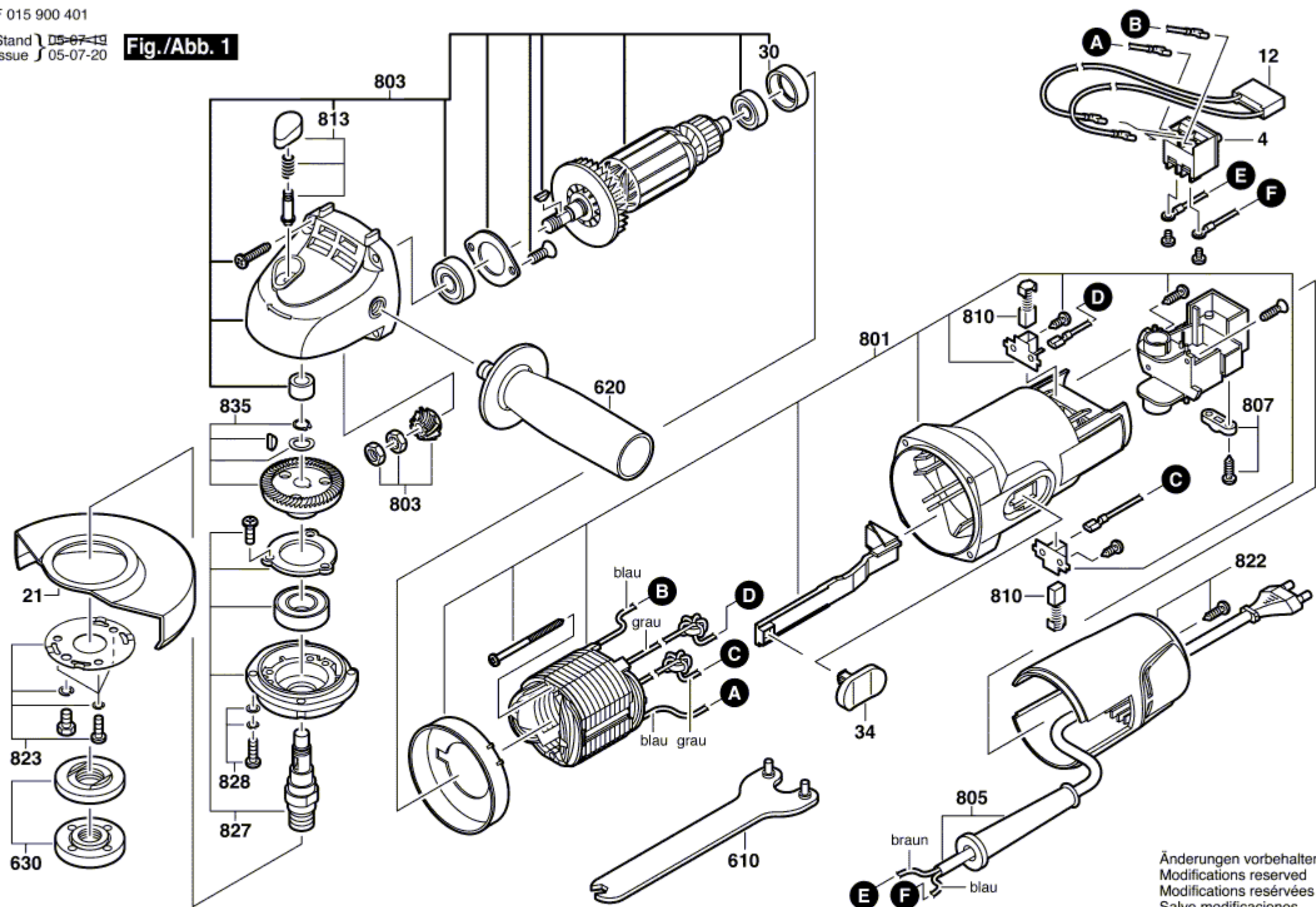

Änderungen vorbehalten
Modifications reserved
Modifications réservées
Salvo modificaciones