

0 801 209 103  
Issue  
Stand ) 13-06-27

**Fig./Abb. 2**

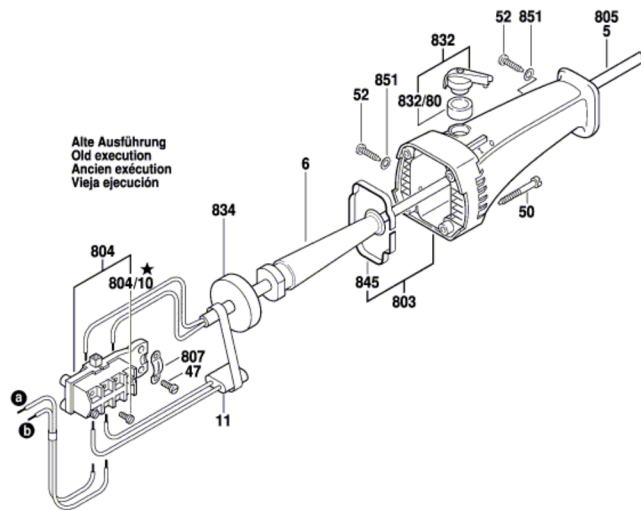

Modifications reserved  
Änderungen vorbehalten  
Modifications réservées  
Salvo modificaciones