

0 603 270 003  
Stand }  
Issue } 09-11-04

**Fig./Abb. 1**

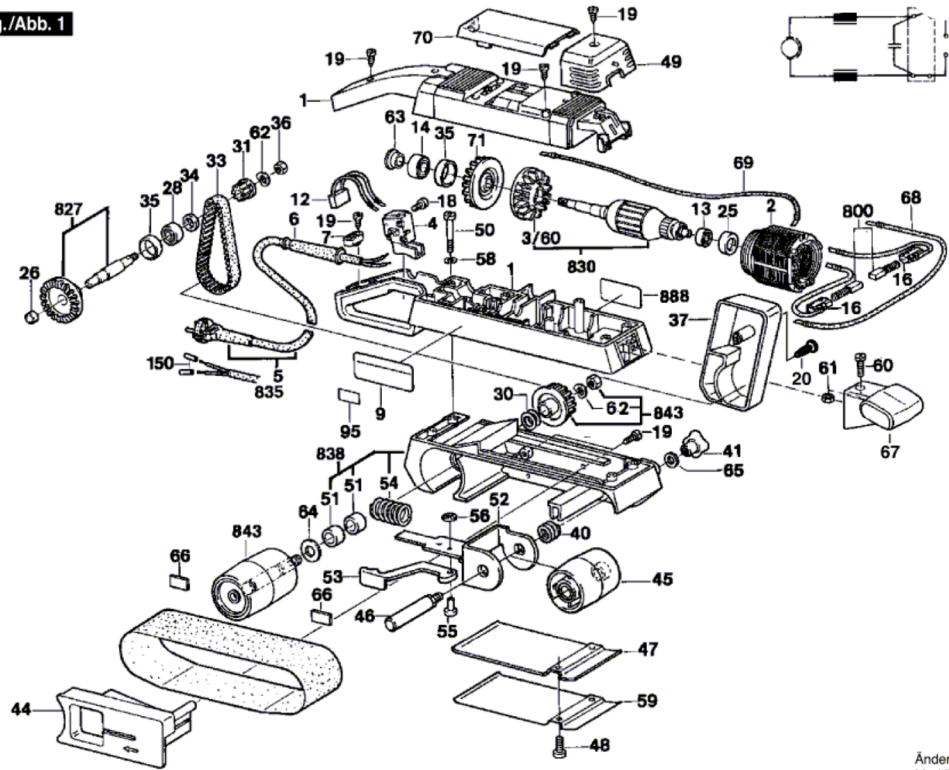

Änderungen vorbehalten  
Modifications reserved  
Modifications reserves  
Salvo modificaciones