

F 015 628 004

Stand } 11-11-28
Issue }

Fig. /Abb. 1

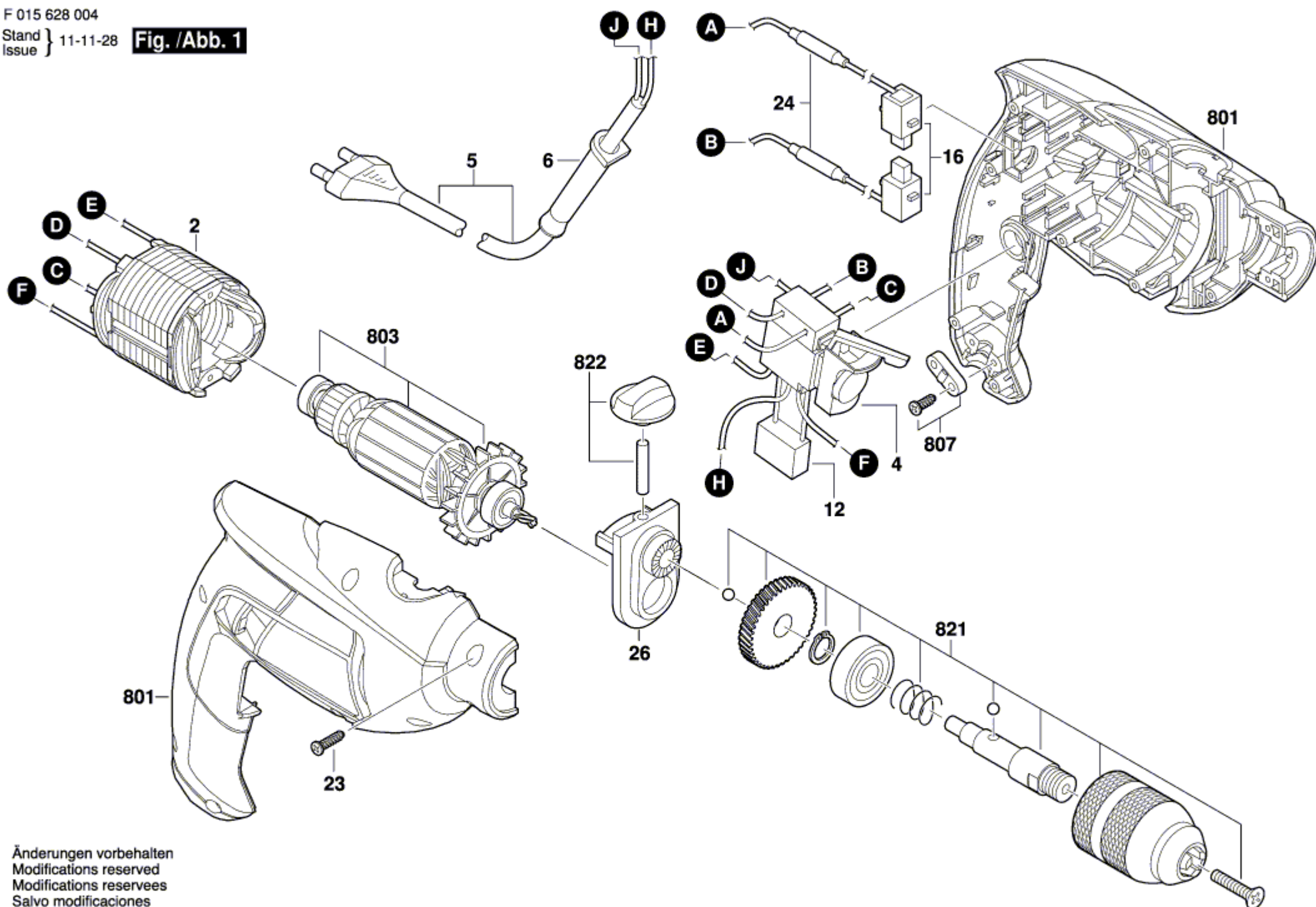

Änderungen vorbehalten
Modifications reserved
Modifications reserves
Salvo modificaciones