

3 601 H60 400

Stand } 08-12
Issue } 09-01-21

Fig./Abb. 1

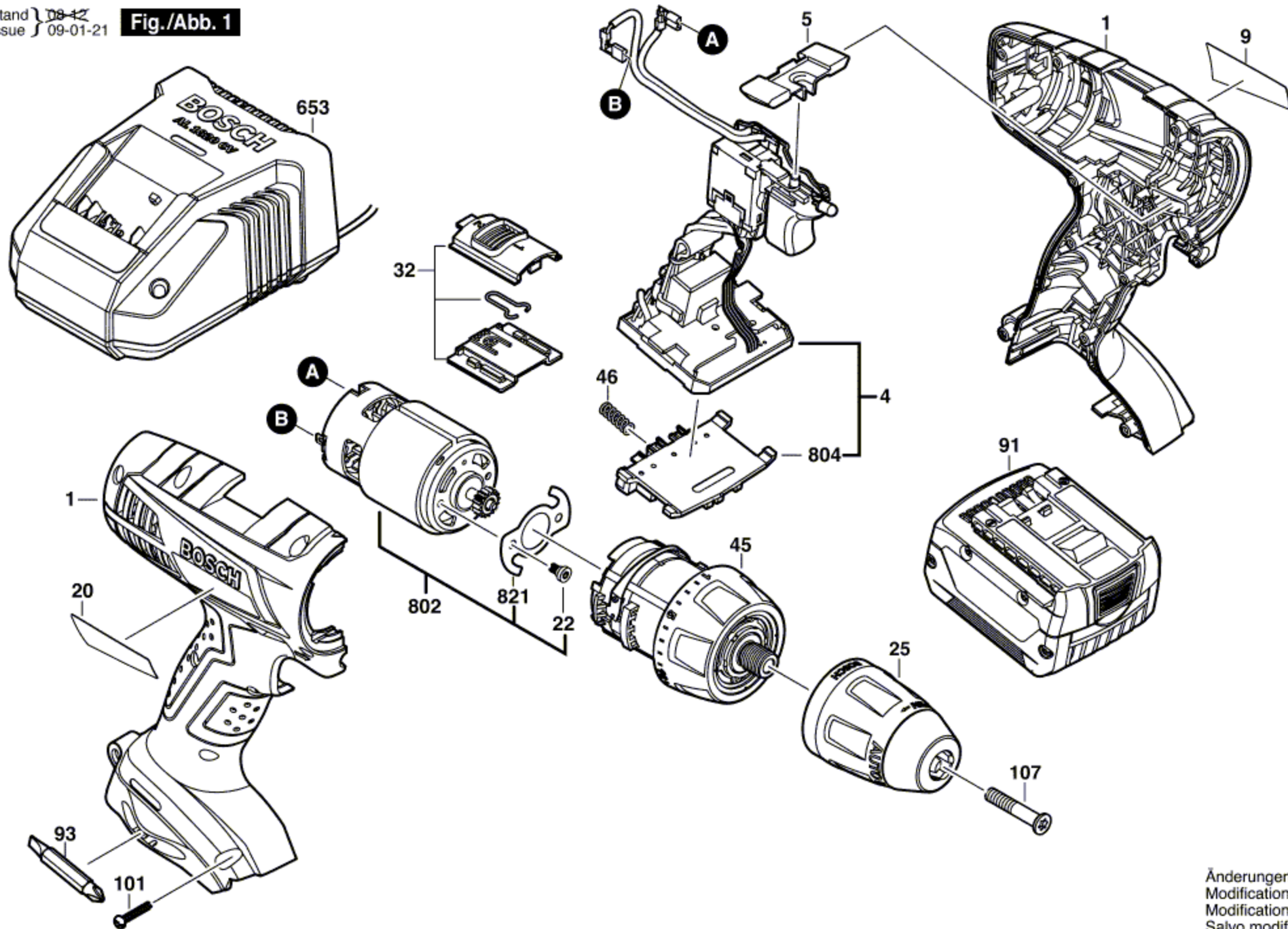

Änderungen vorbehalten
Modifications reserved
Modifications reserves
Salvo modificaciones