

0 603 940 603

Stand 02-11  
Issue 05-03-16

**Fig./Abb. 1**

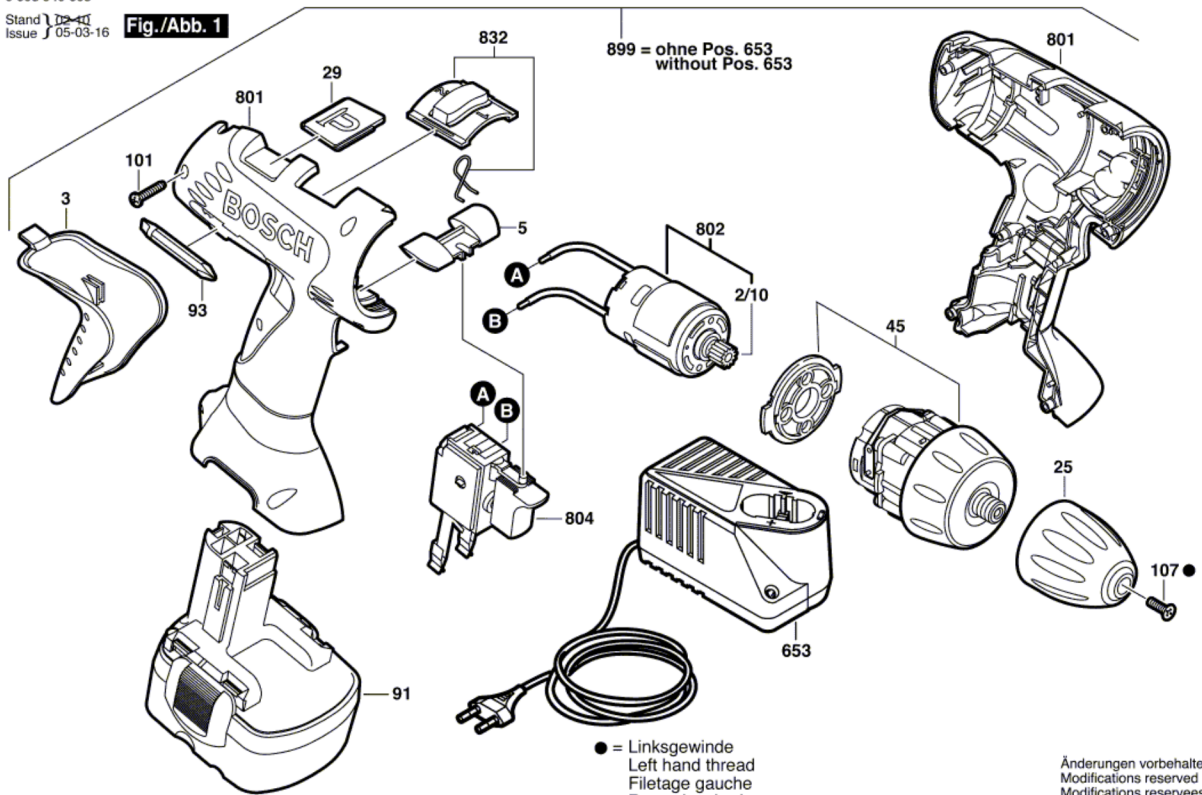

● = Linksgewinde  
Left hand thread  
Filetage gauche  
Rosca izquierda

Änderungen vorbehalten  
Modifications reserved  
Modifications reserves  
Salvo modificaciones