

3 603 A26 000
Stand } 07-10
Issue } 09-01-19 **Fig./Abb. 2**

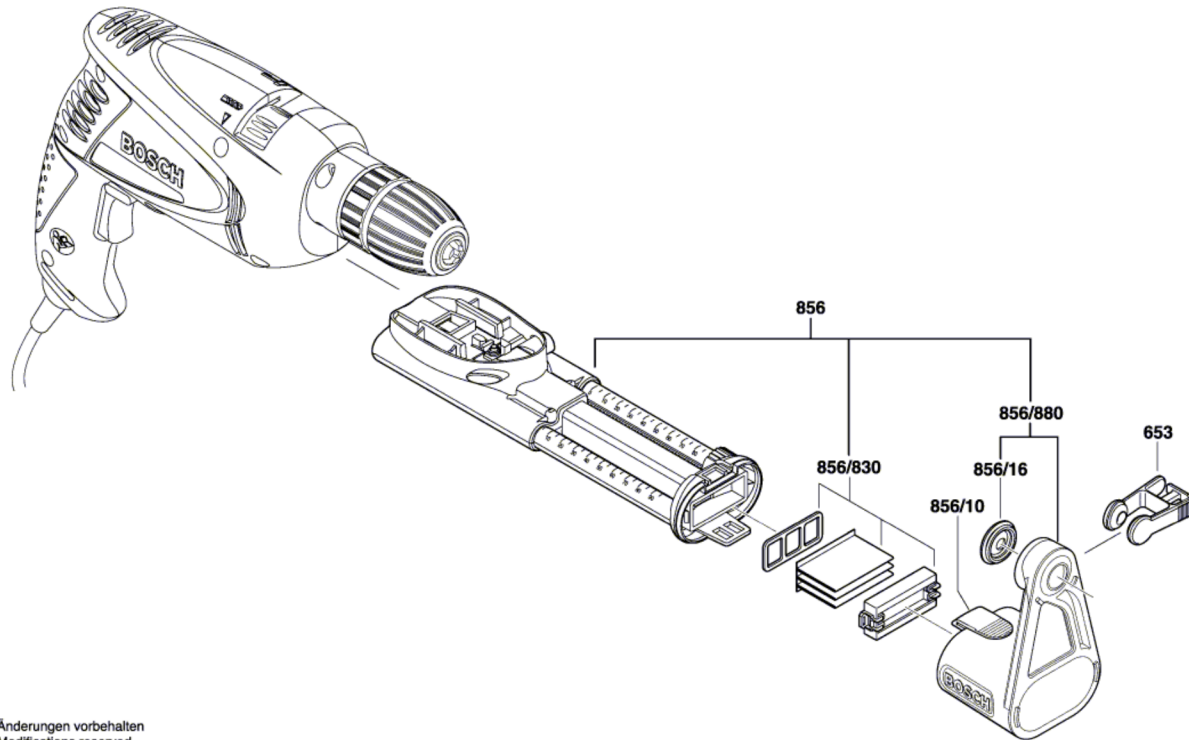

Änderungen vorbehalten
Modifications reserved
Modifications réservées
Salvo modificaciones