

0 603 383 703

Stand } 09-83  
Issue } 00-10-17

**Fig./Abb. 1**

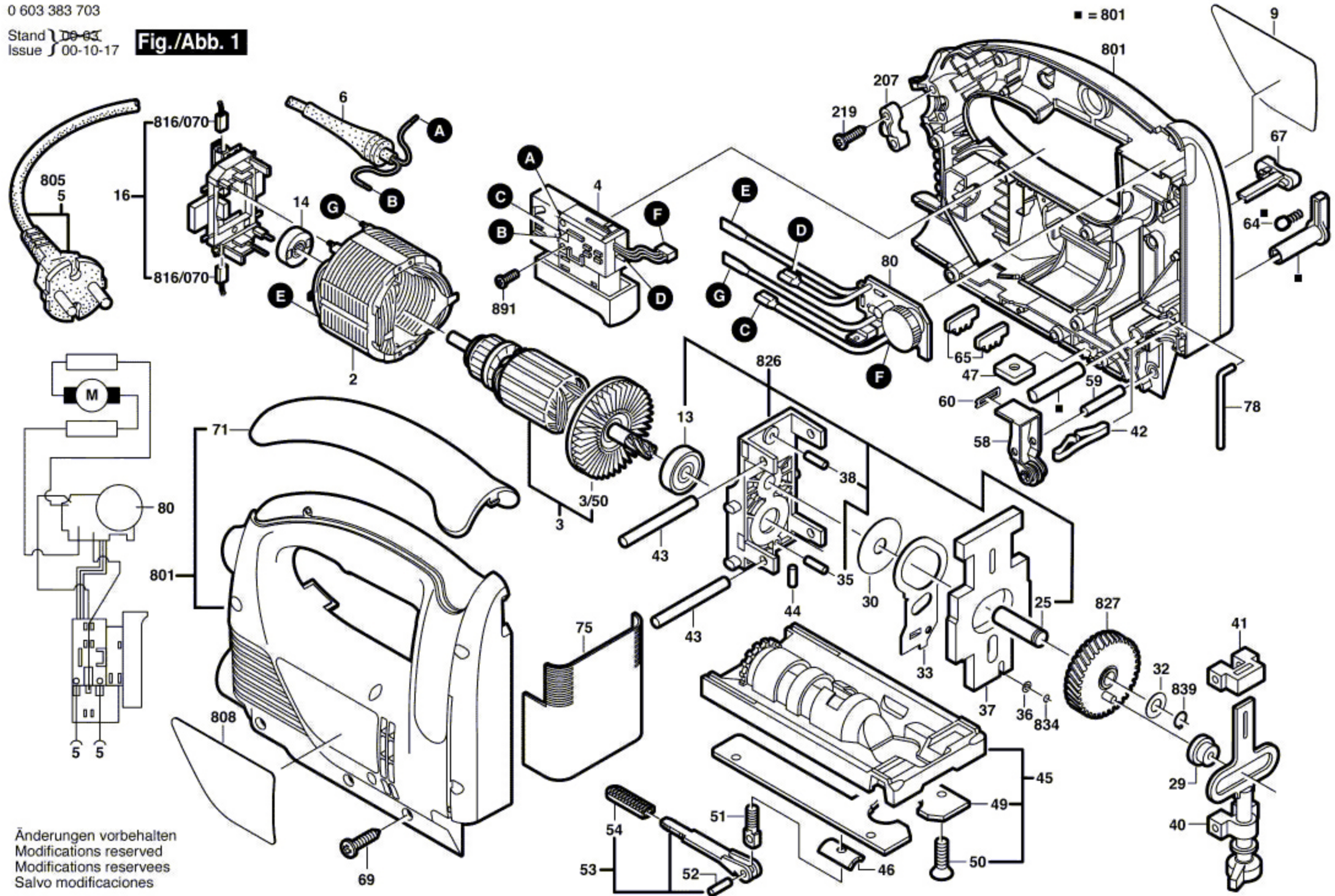

Änderungen vorbehalten  
Modifications reserved  
Modifications reserves  
Salvo modificaciones