

0 603 362 703

Stand } 02-04
Issue } 03-02-06

Fig./Abb. 1

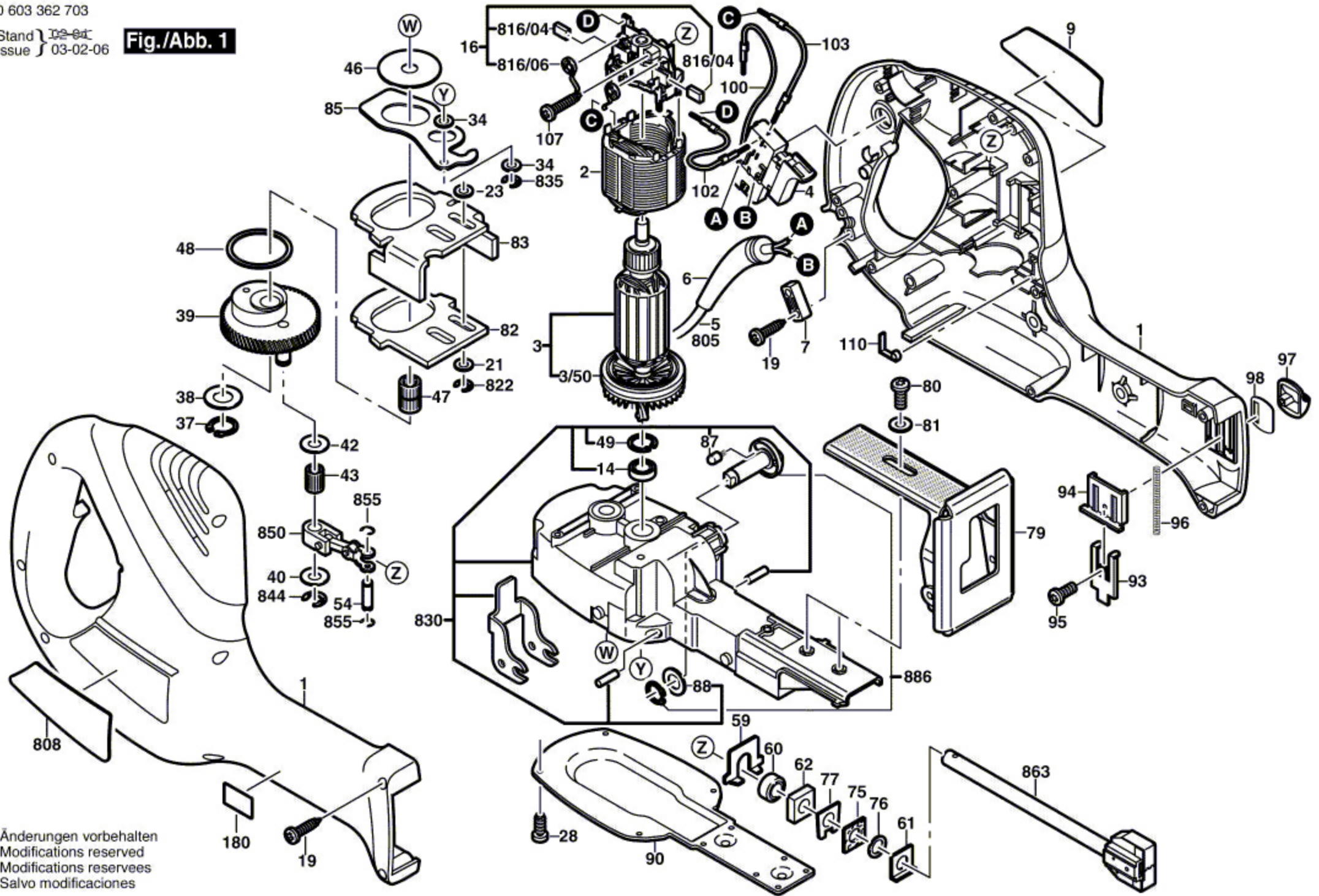

Änderungen vorbehalten
Modifications reserved
Modifications reserves
Salvo modificaciones