

0 603 328 080

Issue } 05-02-22
Stand }

Fig./Abb. 1

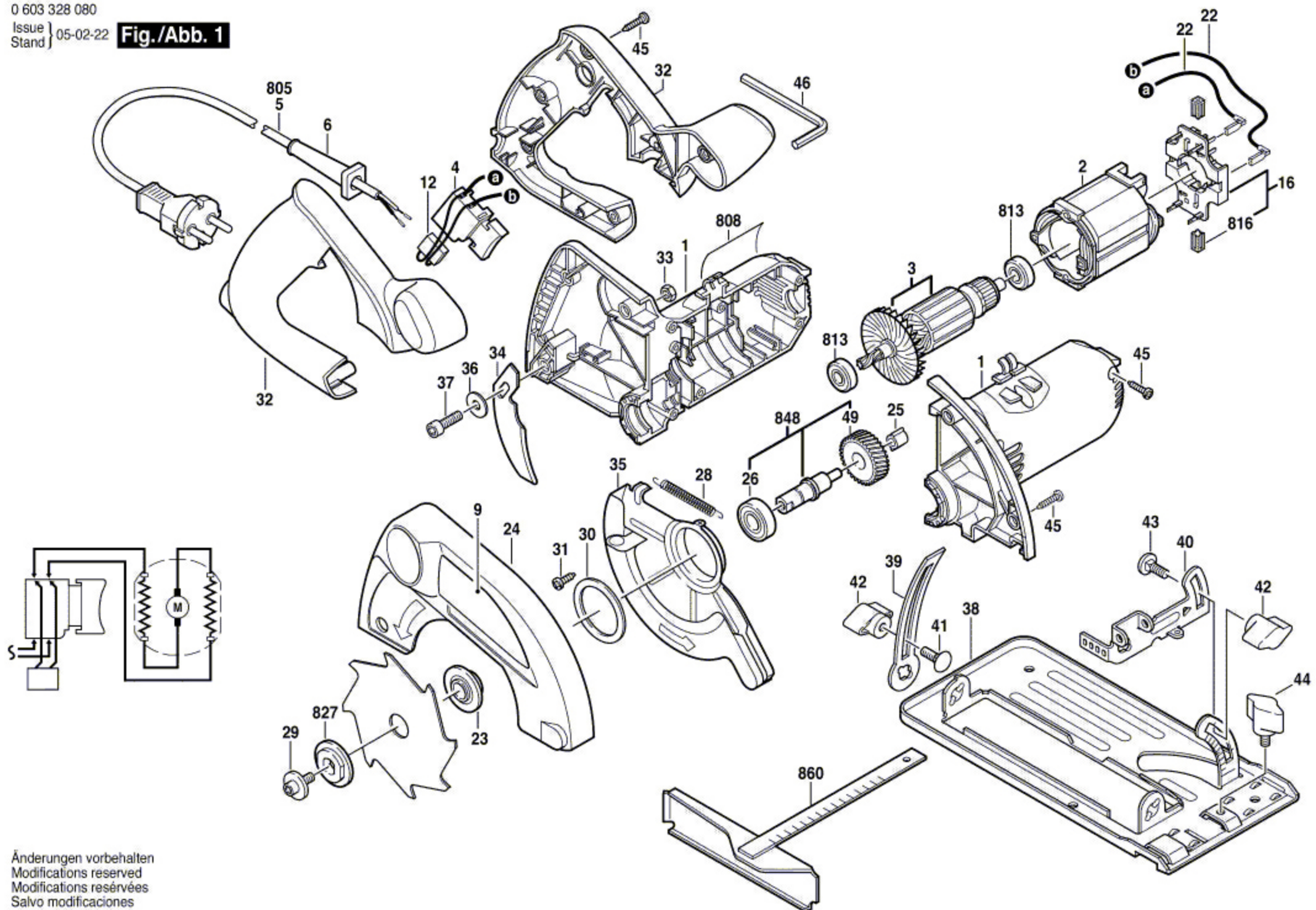

Änderungen vorbehalten
Modifications reserved
Modifications réservées
Salvo modificaciones