

0 601 593 103
Stand } 12-08
Issue } 08-06-04

Fig./Abb. 2

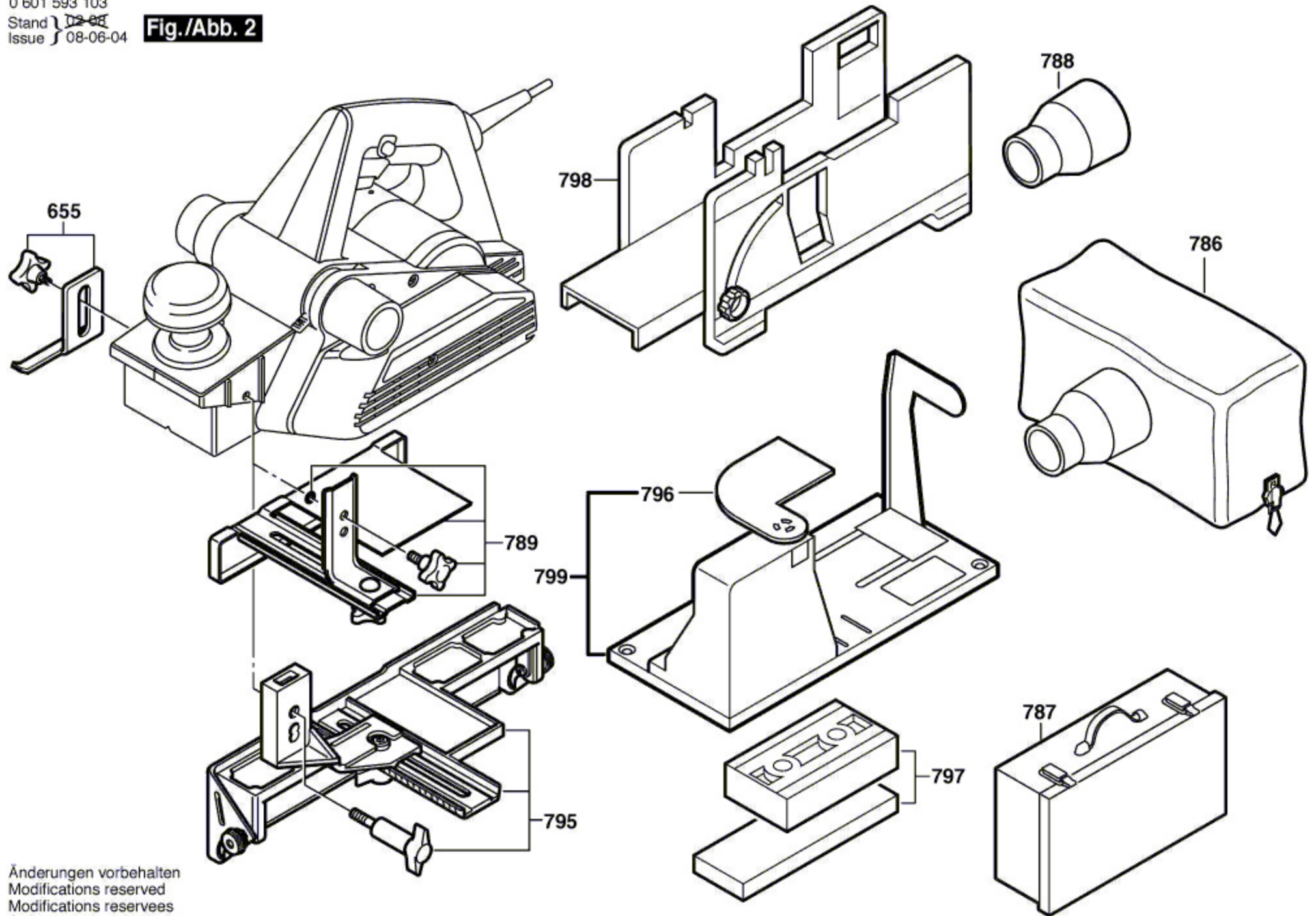

Änderungen vorbehalten
Modifications reserved
Modificaciones reservadas
Salvo modificaciones