

0 601 292 703

Stand } 02-07  
Issue } 03-01-15

**Fig./Abb. 2**

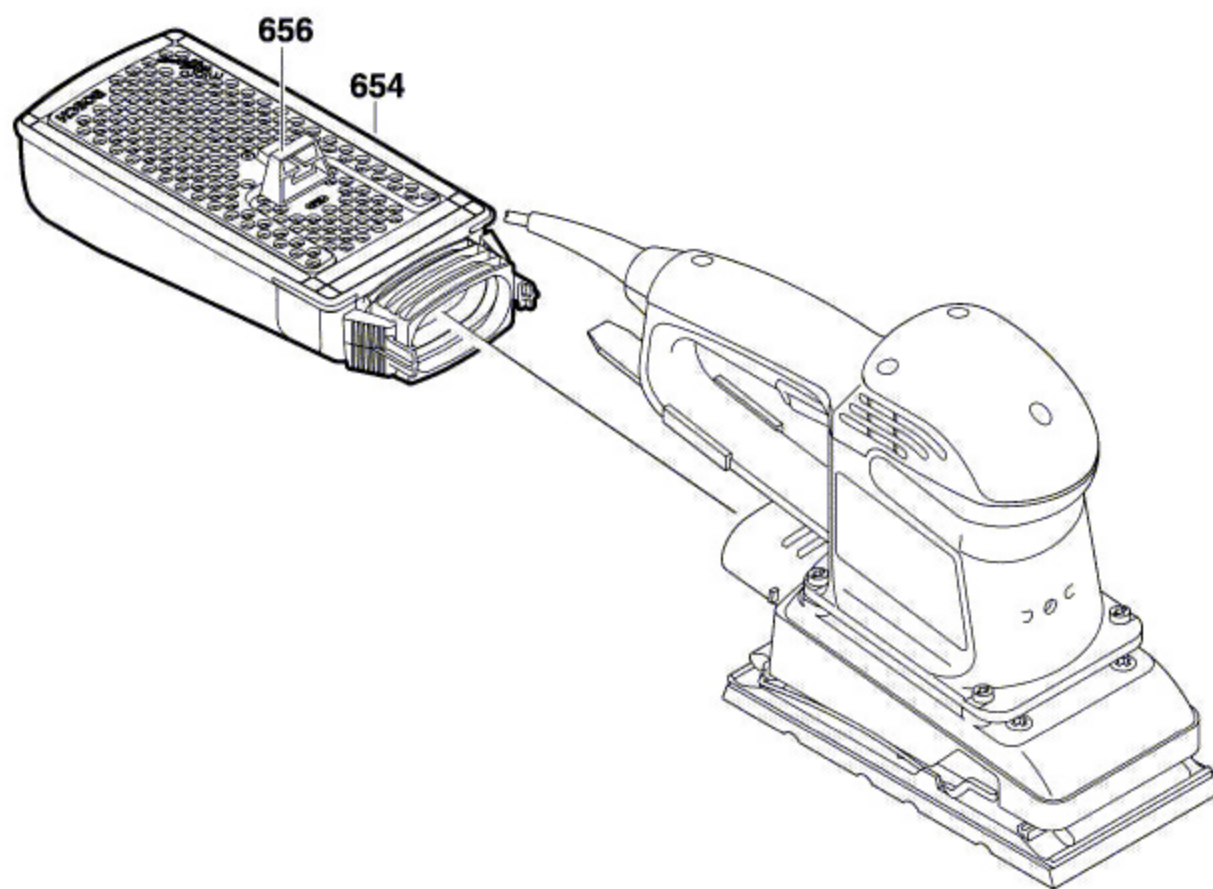

Änderungen vorbehalten  
Modifications reserved  
Modificaciones reservadas  
Salvo modificaciones

