

0 611 250 703

Issue } 10-06-07 **Fig./Abb. 2**
Stand }

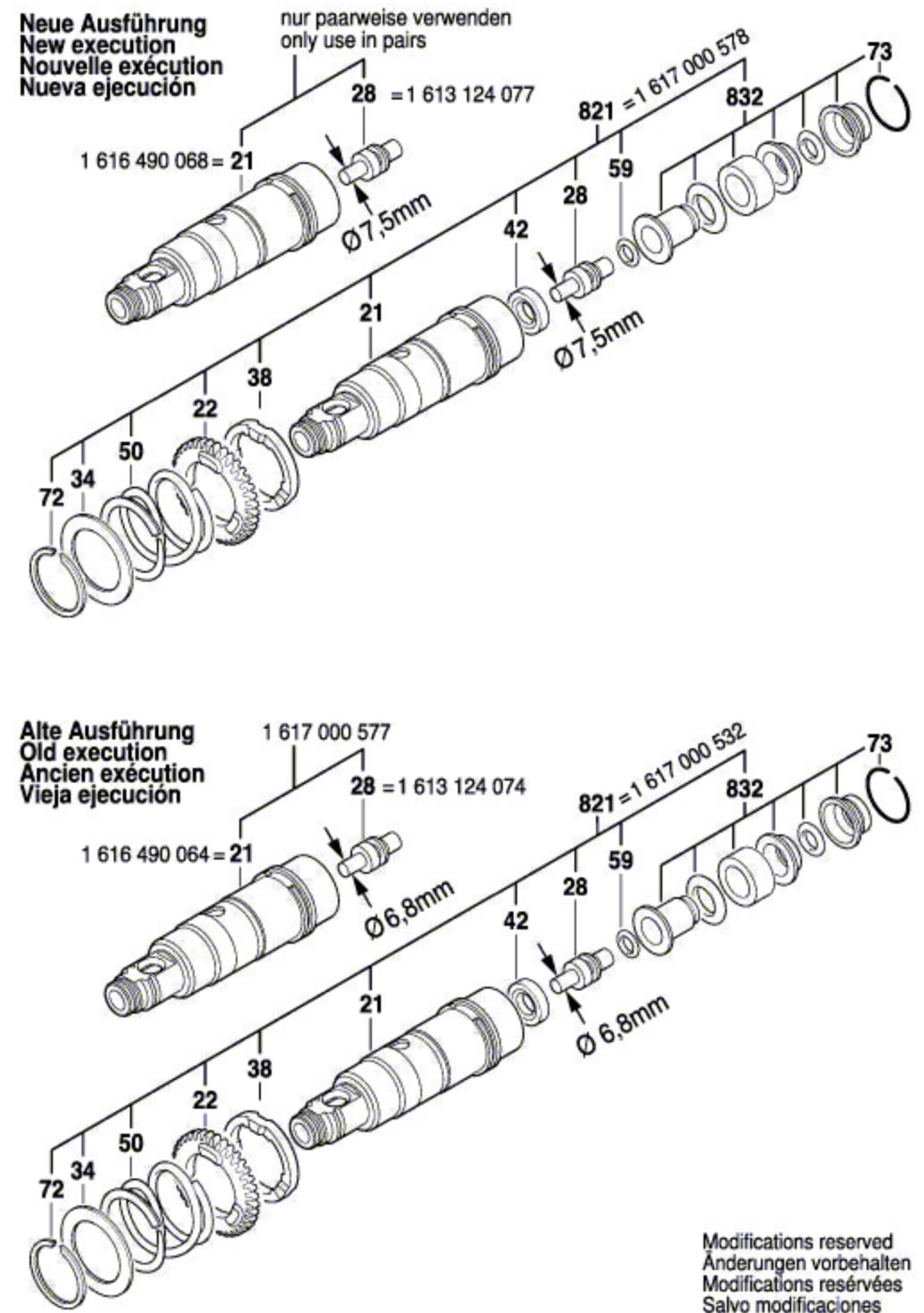
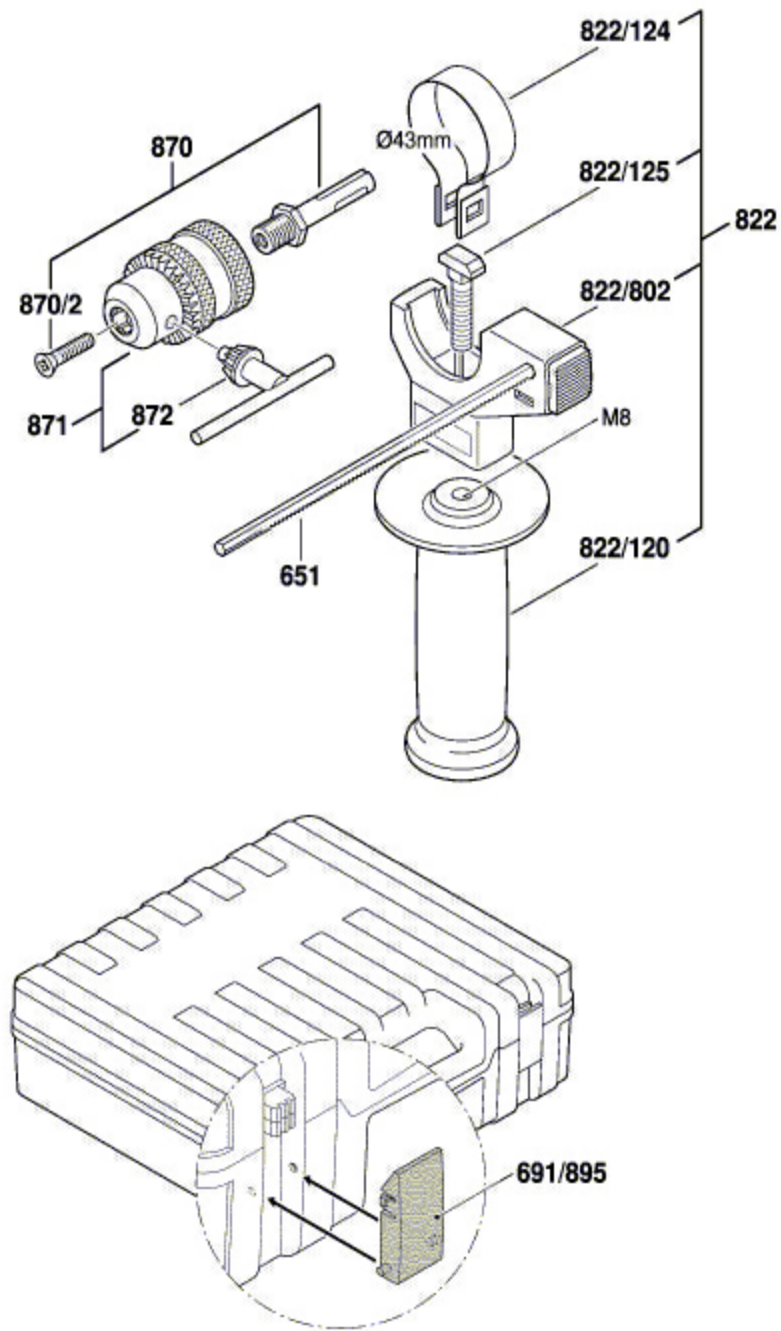

Modifications reserved
Änderungen vorbehalten
Modifications réservées
Salvo modificaciones