

F 015 638 701

Stand } 09-01-13
Issue }

Fig./Abb. 1

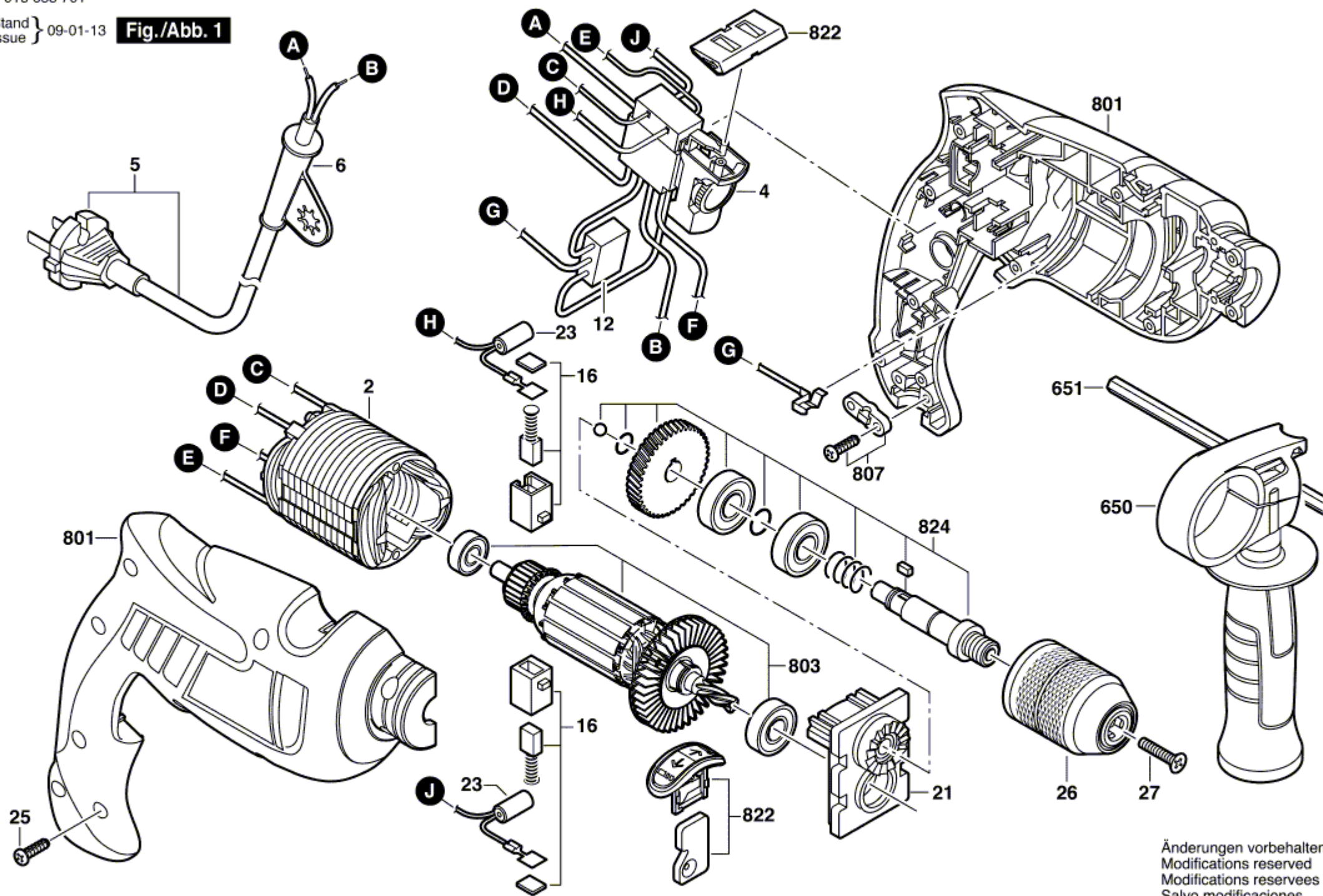

Änderungen vorbehalten
Modifications reserved
Modificaciones reservadas
Salvo modificaciones