

3 601 C88 204  
Stand } 16-01-20 **Fig./Abb. 2**  
Issue }

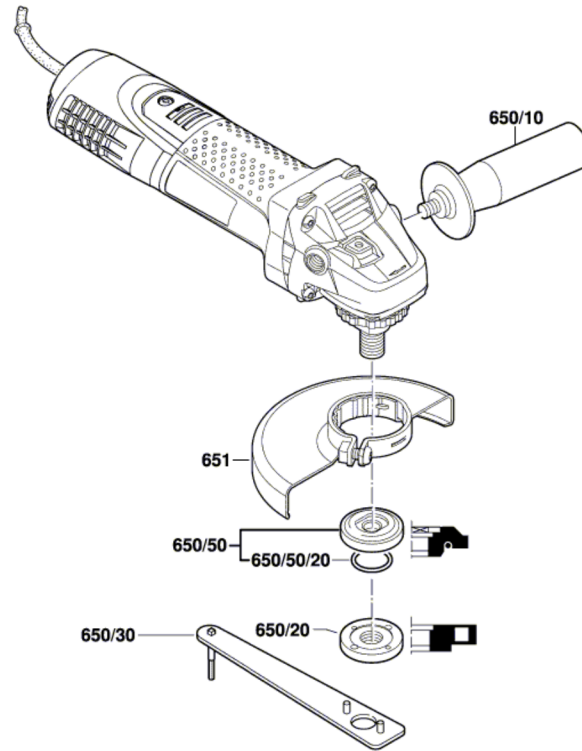

Änderungen vorbehalten  
Modifications reserved  
Modifications réservées  
Salvo modificaciones