

F 015 252 101

Stand } 10-01-12
Issue } 10-01-18

Fig./Abb. 1

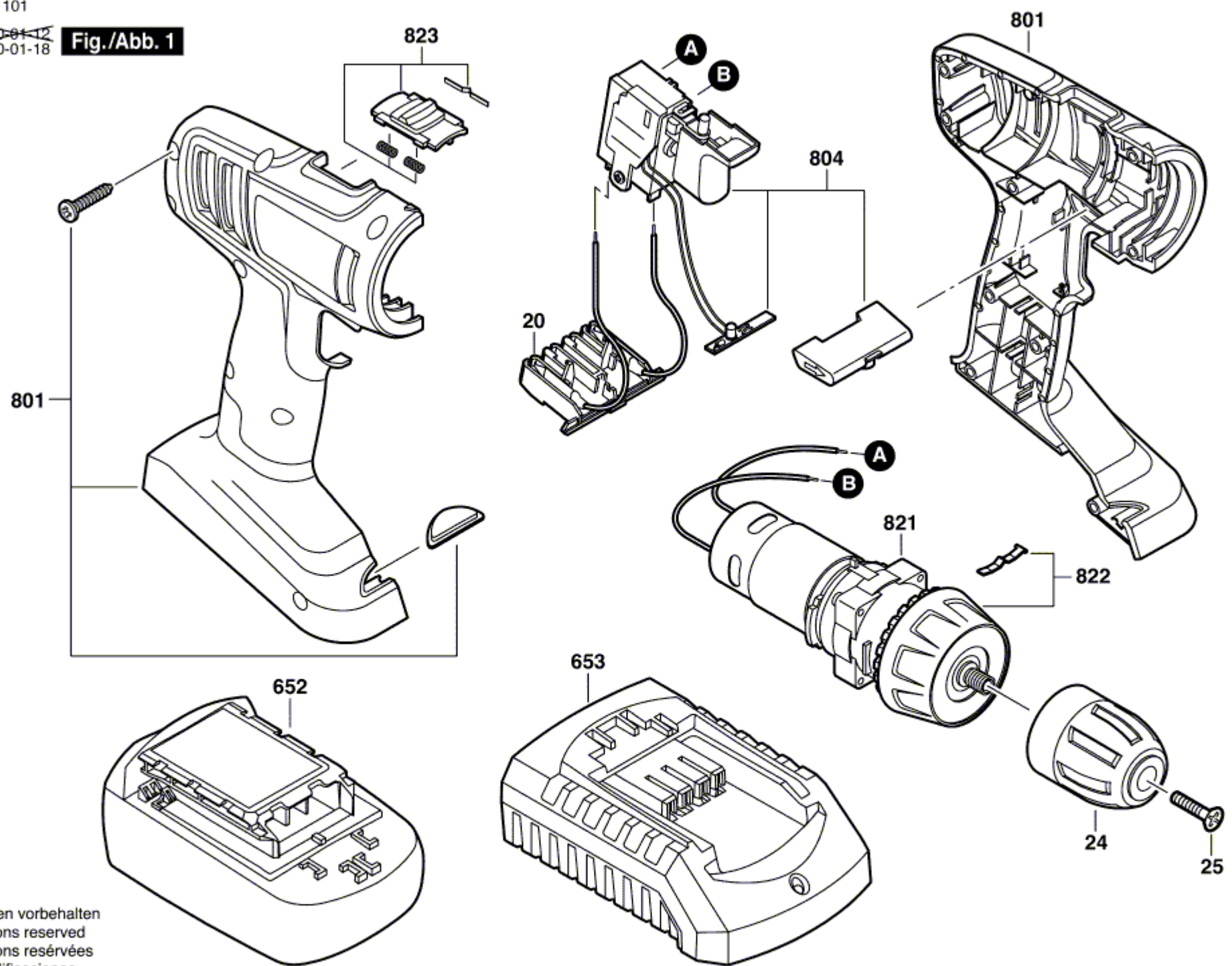

Änderungen vorbehalten
Modifications reserved
Modifications réservées
Salvo modificaciones