

F 013 400 045

Stand } 10-01-21  
Issue }

**Fig. /Abb. 1**

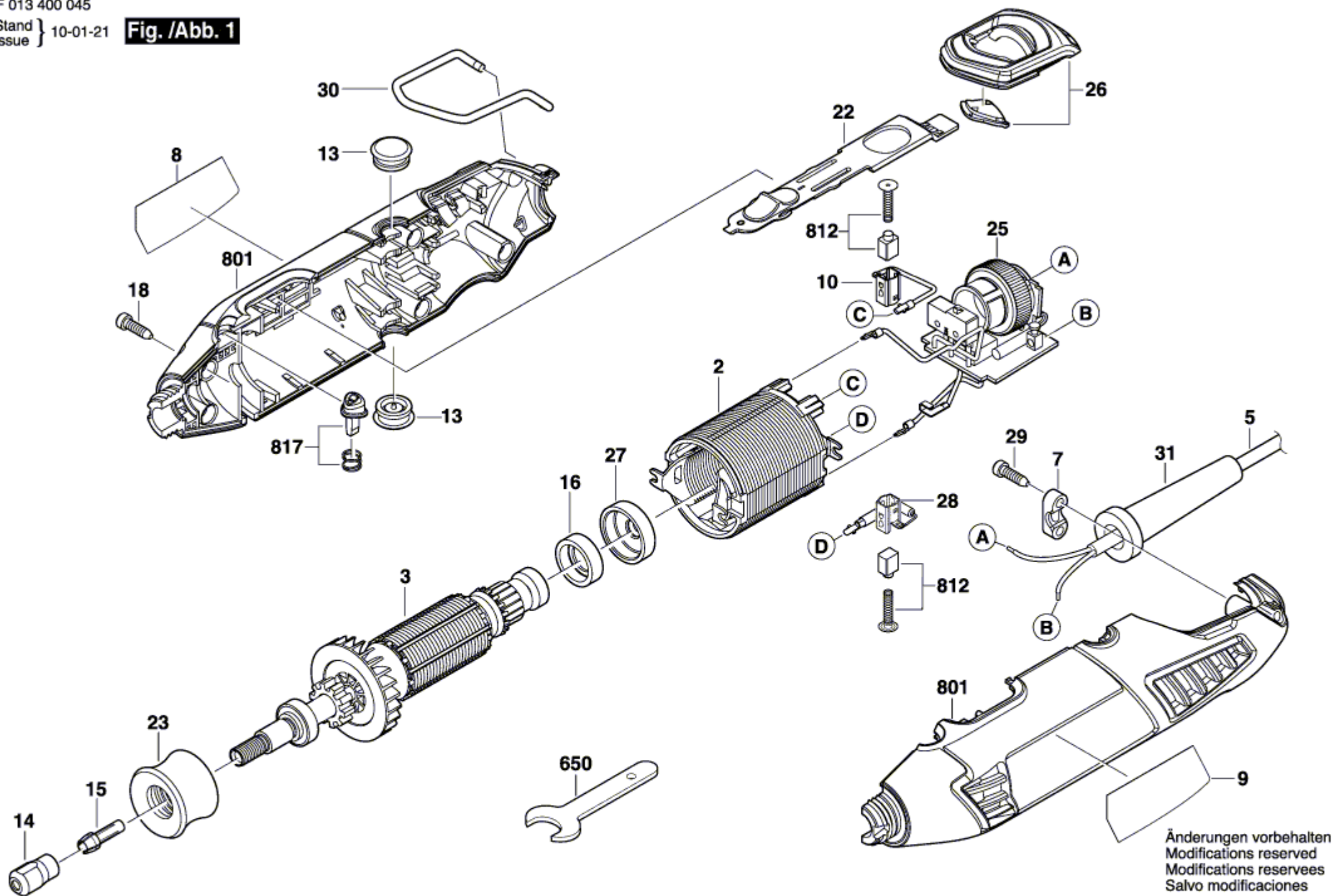

Änderungen vorbehalten  
Modifications reserved  
Modificaciones reservadas  
Salvo modificaciones