

3 601 G96 000

Stand } 11-12
Issue } 14-07-01

Fig./Abb. 1

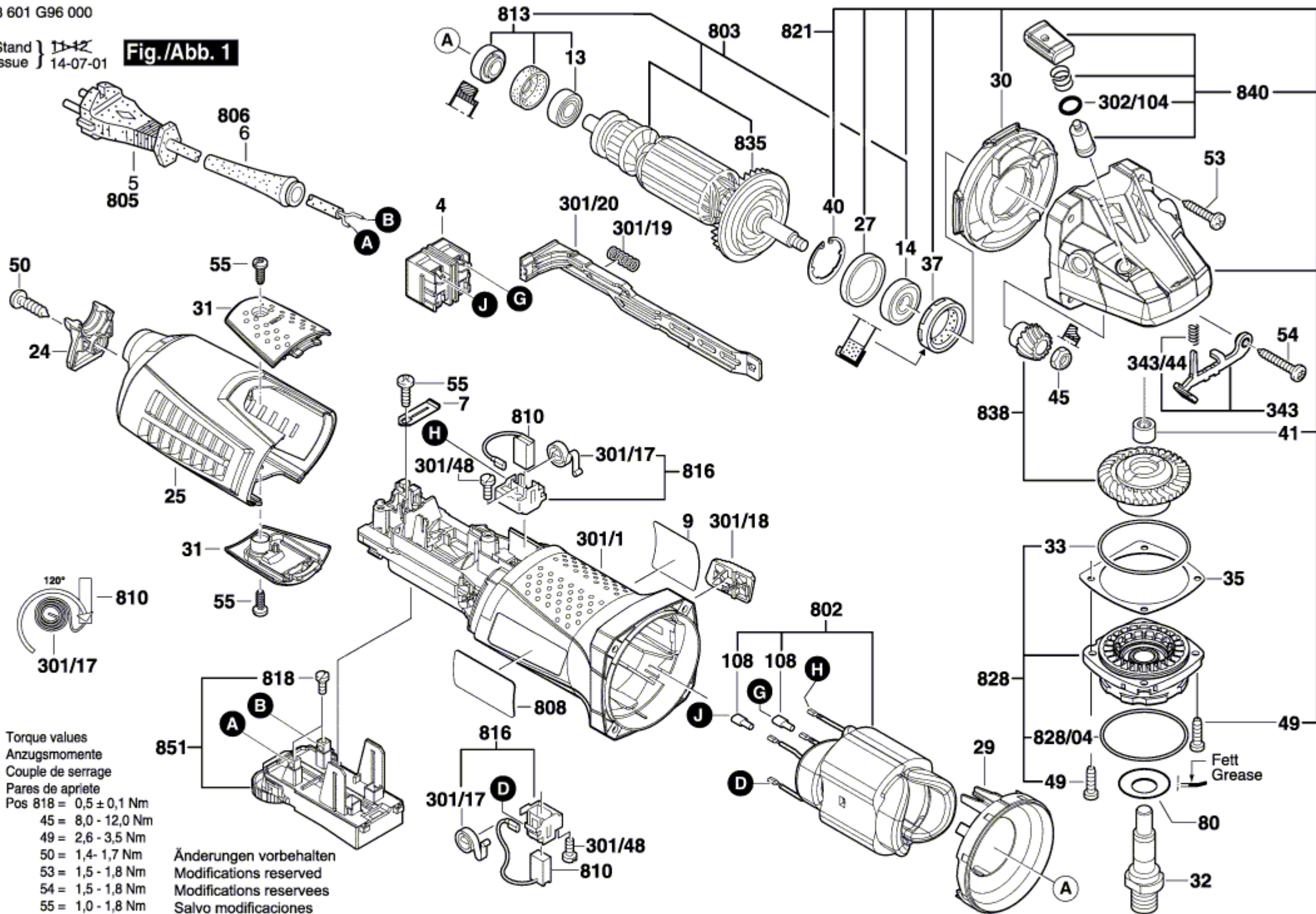

Torque values
Anzugsmomente
Couple de serrage
Pares de apriete
Pos 818 = 0,5 ± 0,1 Nm
45 = 8,0 - 12,0 Nm
49 = 2,6 - 3,5 Nm
50 = 1,4 - 1,7 Nm
53 = 1,5 - 1,8 Nm
54 = 1,5 - 1,8 Nm
55 = 1,0 - 1,8 Nm

Änderungen vorbehalten
Modifications reserved
Modifications reservees
Salvo modificaciones