

3 601 H32 000

Stand } 08-02
Issue } 07-03-23

Fig./Abb. 2

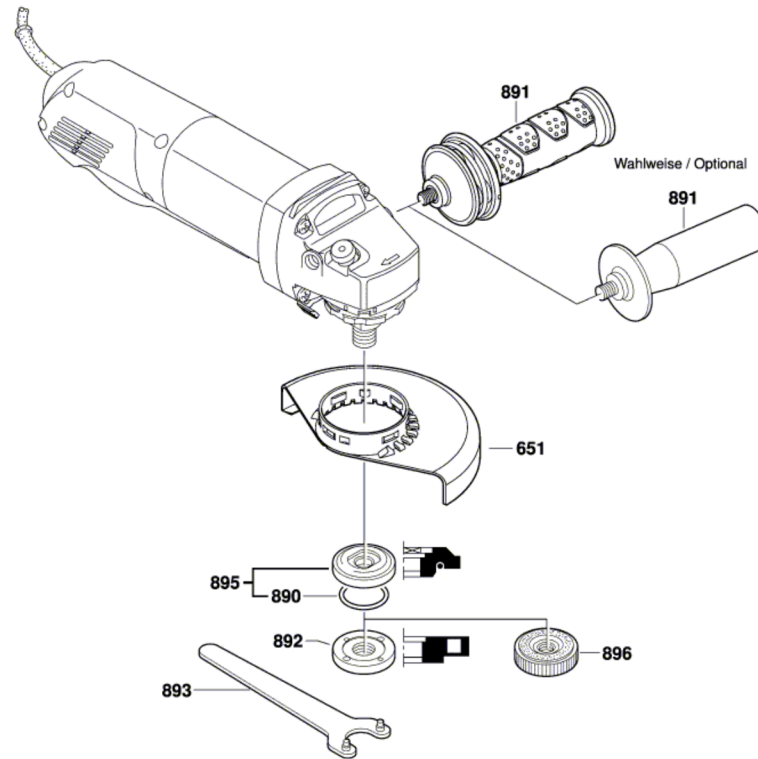

Änderungen vorbehalten
Modifications reserved
Modifications reserves
Salvo modificaciones