

3 603 A26 200  
Stand } 08-02  
Issue } 09-01-19

**Fig./Abb. 2**

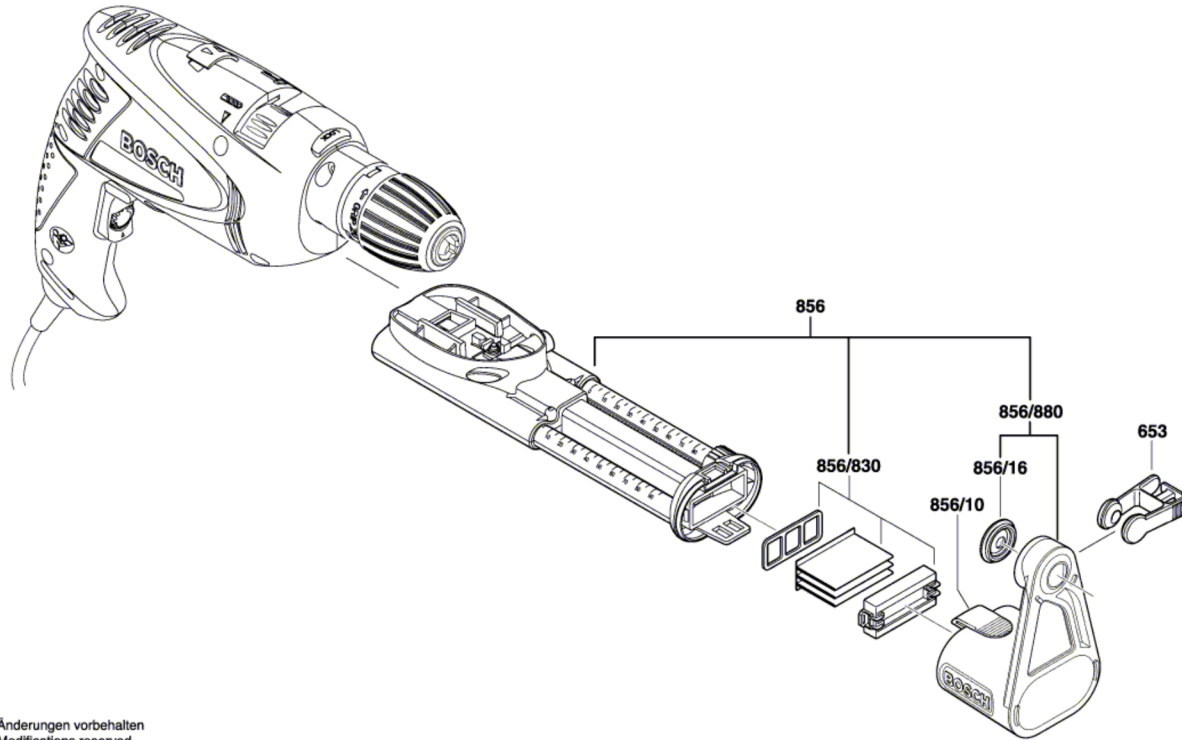

Änderungen vorbehalten  
Modifications reserved  
Modifications réservées  
Salvo modificaciones