

3 603 A26 002

Stand } 07-10
Issue } 09-01-19

Fig./Abb. 2

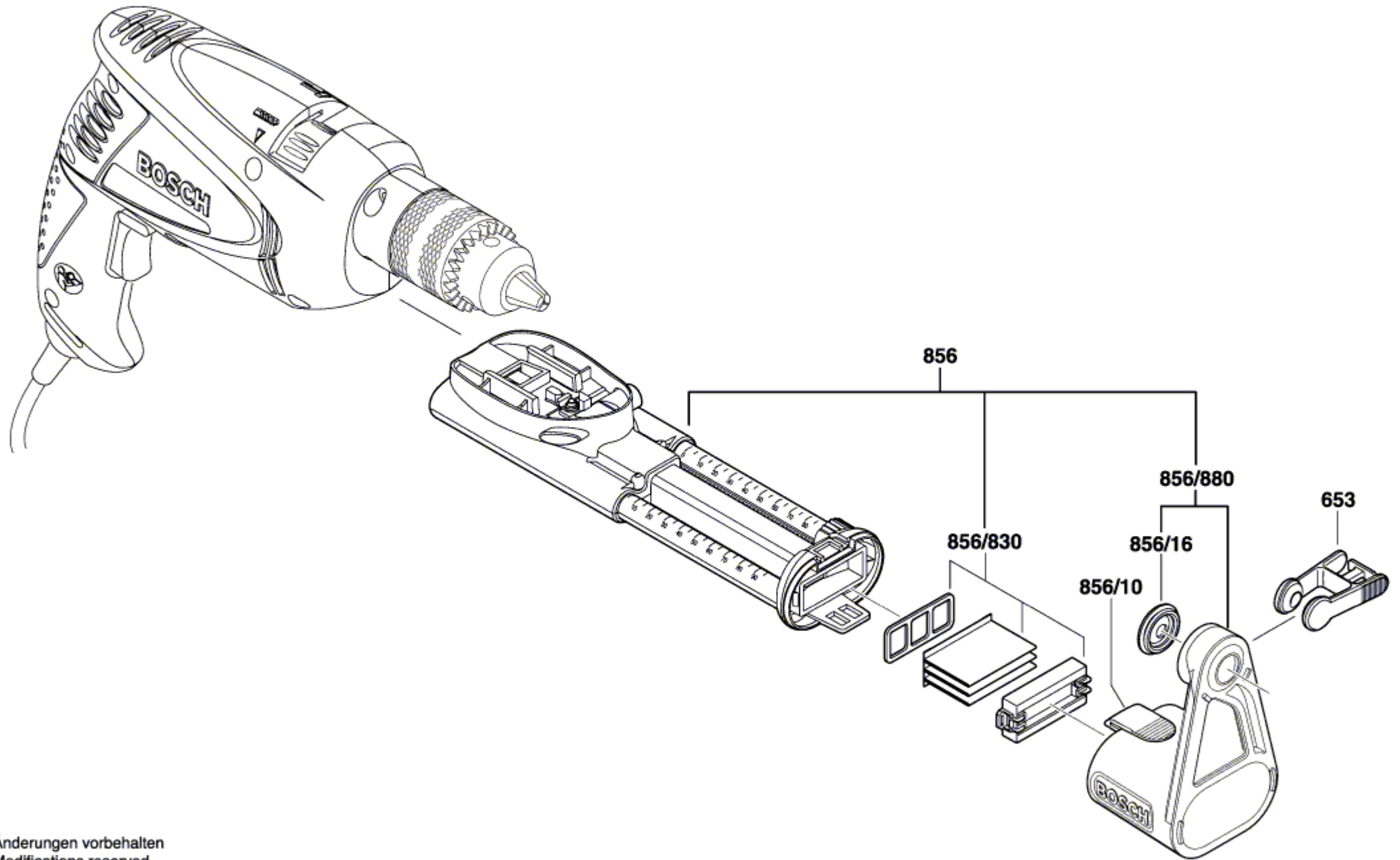

Änderungen vorbehalten
Modifications reserved
Modifications réservées
Salvo modificaciones