

0 611 253 703  
Issue  
Stand

14-10-29 **Fig./Abb. 2**

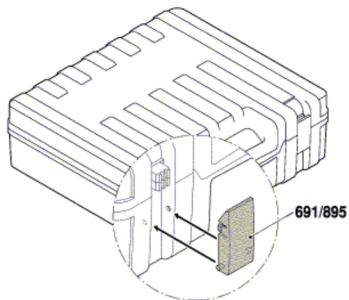
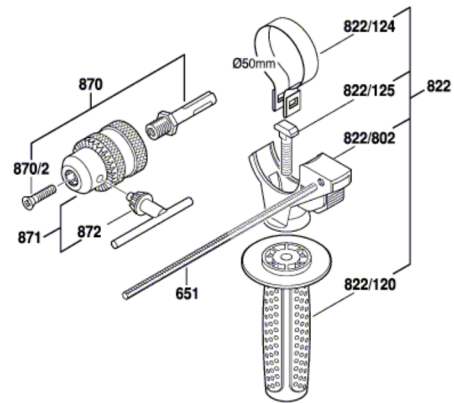

Modifications reserved  
Änderungen vorbehalten  
Modifications réservées  
Salvo modificaciones