

0 611 226 703  
 Issue | 06-09-25  
 Stand |

**Fig./Abb. 2**

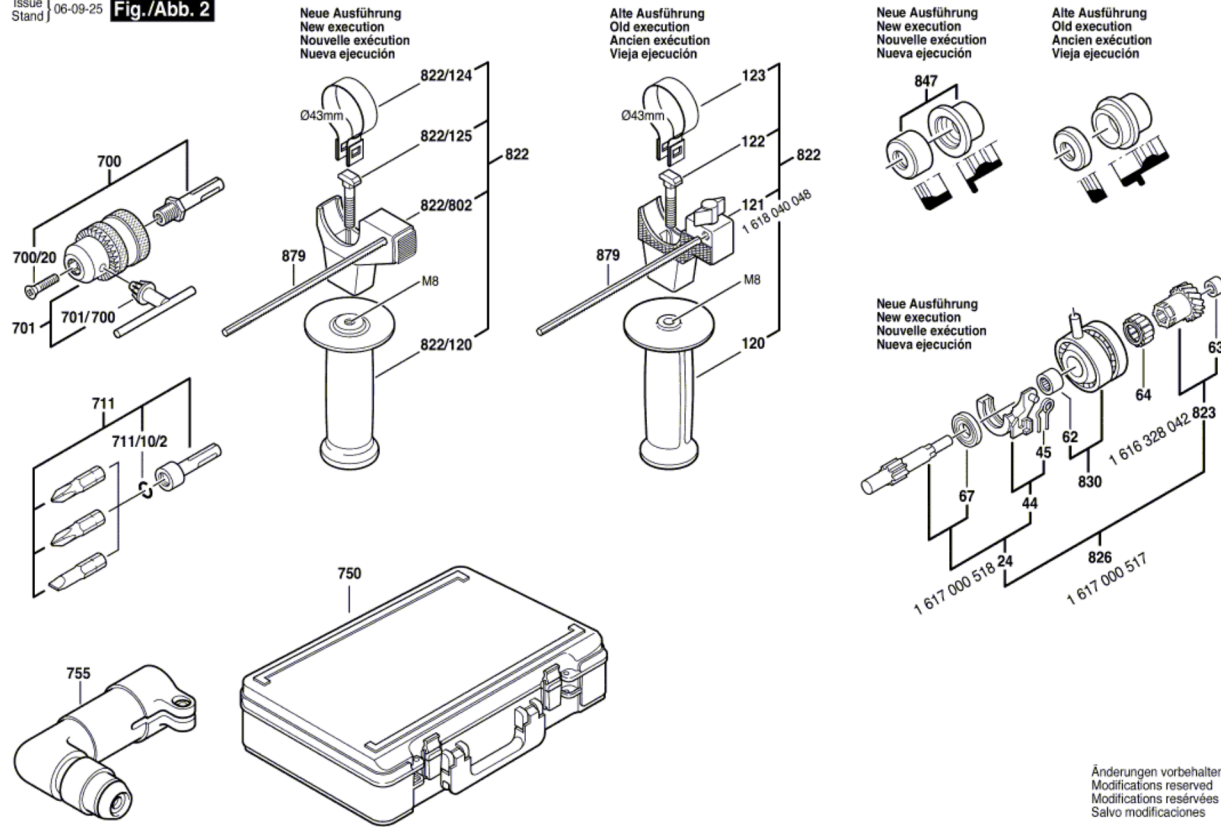

Änderungen vorbehalten  
 Modifications reserved  
 Modifications réservées  
 Salvo modificaciones