

3 611 967 500  
Issue  
Stand | 16-10-26

**Fig./Abb. 2**

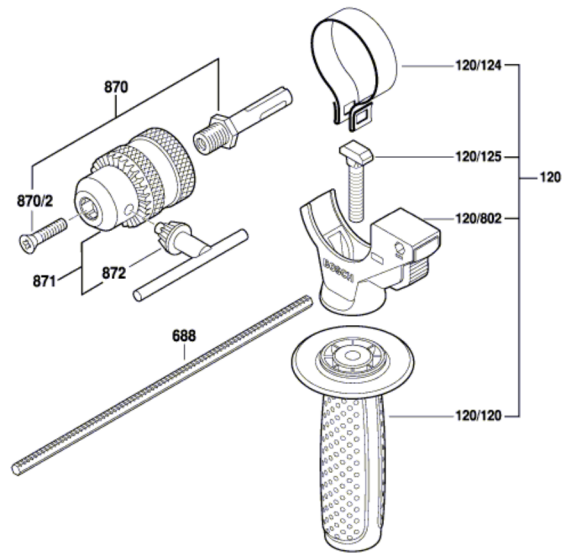

Modifications reserved  
Änderungen vorbehalten  
Modifications réservées  
Salvo modificaciones