

0 601 352 820
Stand 10-18
Issue 02-04-24

Fig./Abb. 2

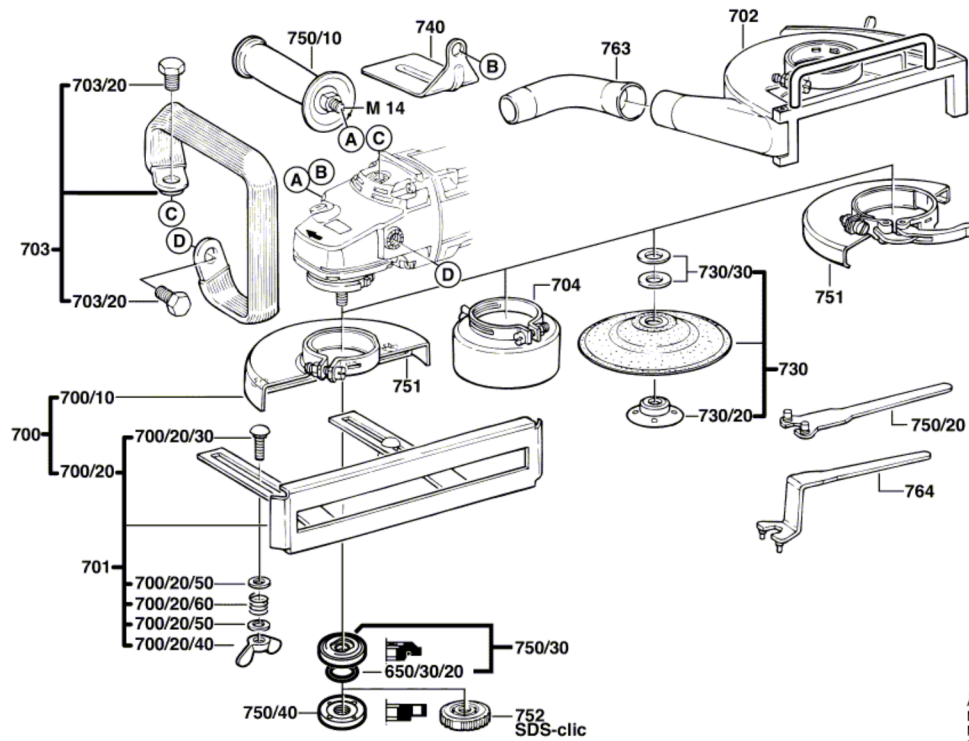

Änderungen vorbehalten
Modifications reserved
Modifications reserves
Salvo modificaciones