

0 601 752 922
Stand 39-1
Issue J 00-12-06

Fig./Abb. 2

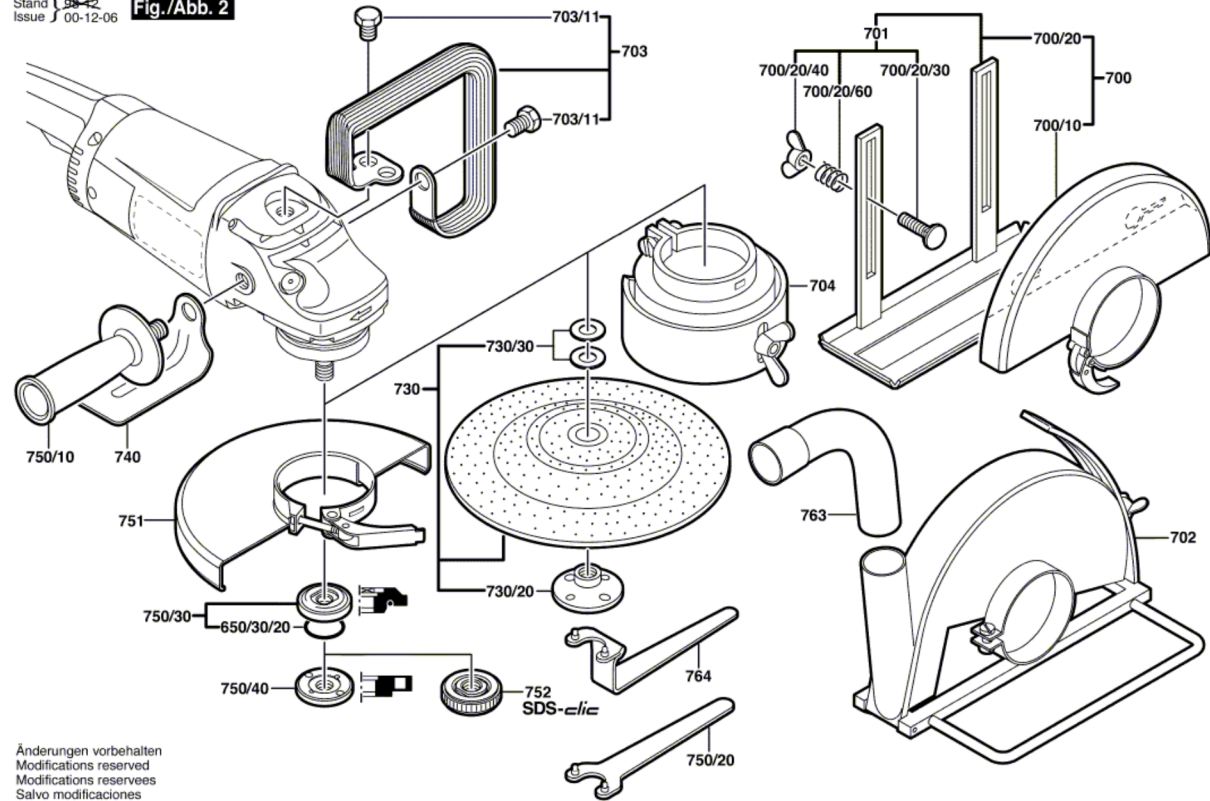

Änderungen vorbehalten
Modifications reserved
Modifications reserves
Salvo modificaciones