

0 611 231 703  
Issue | 03-06-05  
Stand | **Fig./Abb. 2**

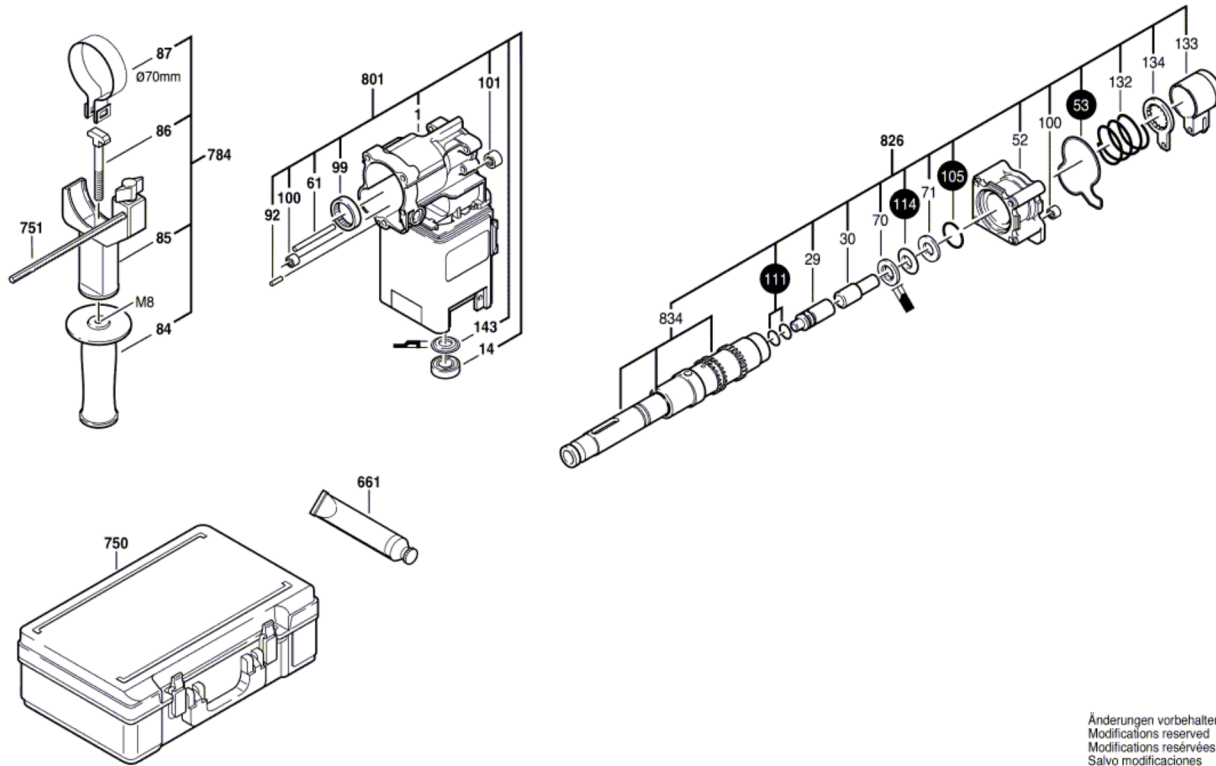

Änderungen vorbehalten  
Modifications reserved  
Modifications réservées  
Salvo modificaciones