

3 601 H92 F02
Stand } 18-05
Issue } 18-07-23

Fig./Abb. 2

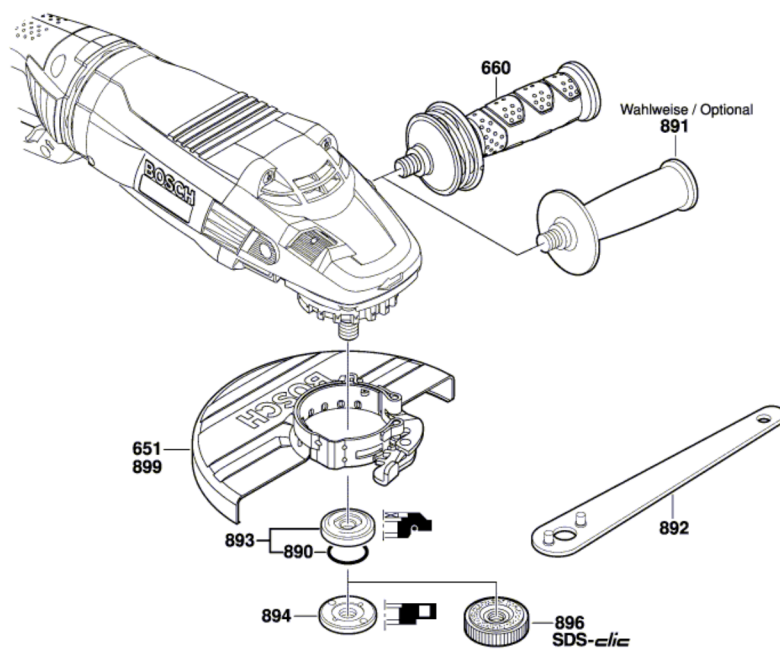

Änderungen vorbehalten
Modifications reserved
Modifications réservées
Salvo modificaciones