

0 603 329 003

Stand 199-11
Issue 99-12-22

Fig./Abb. 1

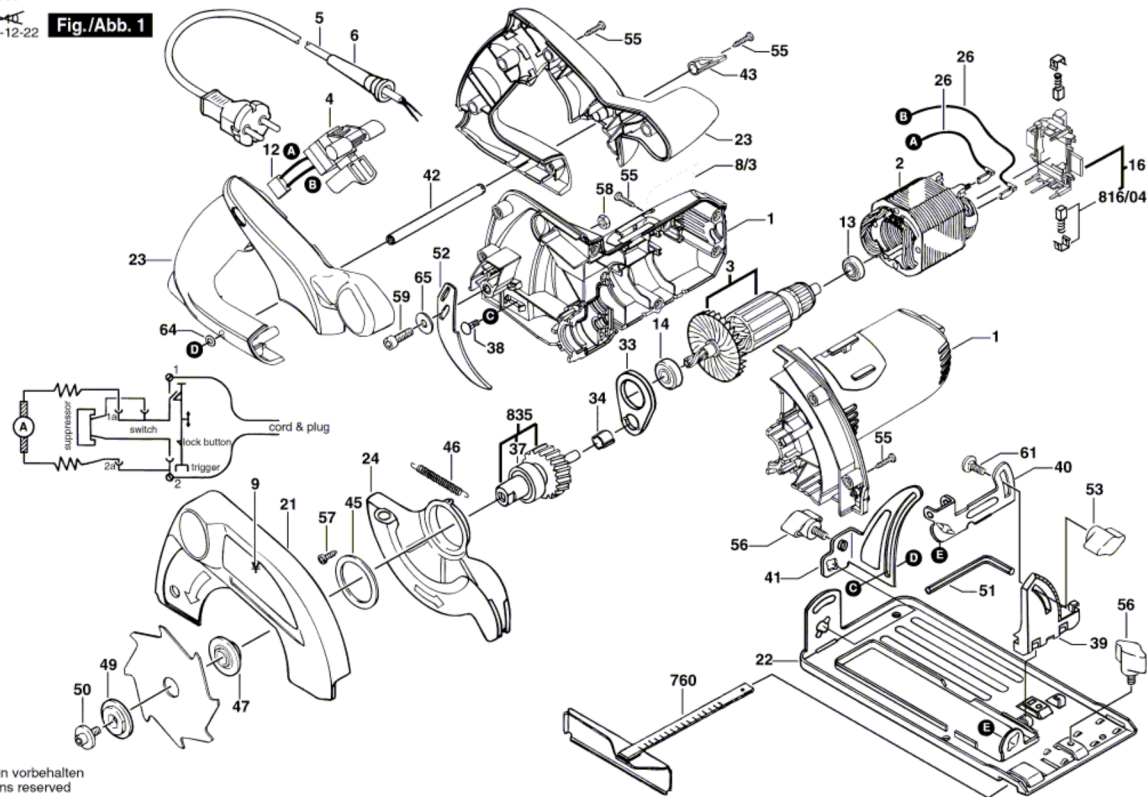

Änderungen vorbehalten
Modifications reserved
Modifications reserves
Salvo modificaciones