

3 603 A02 000
Stand | 18-03
Issue | 17-10-26

Fig./Abb. 1

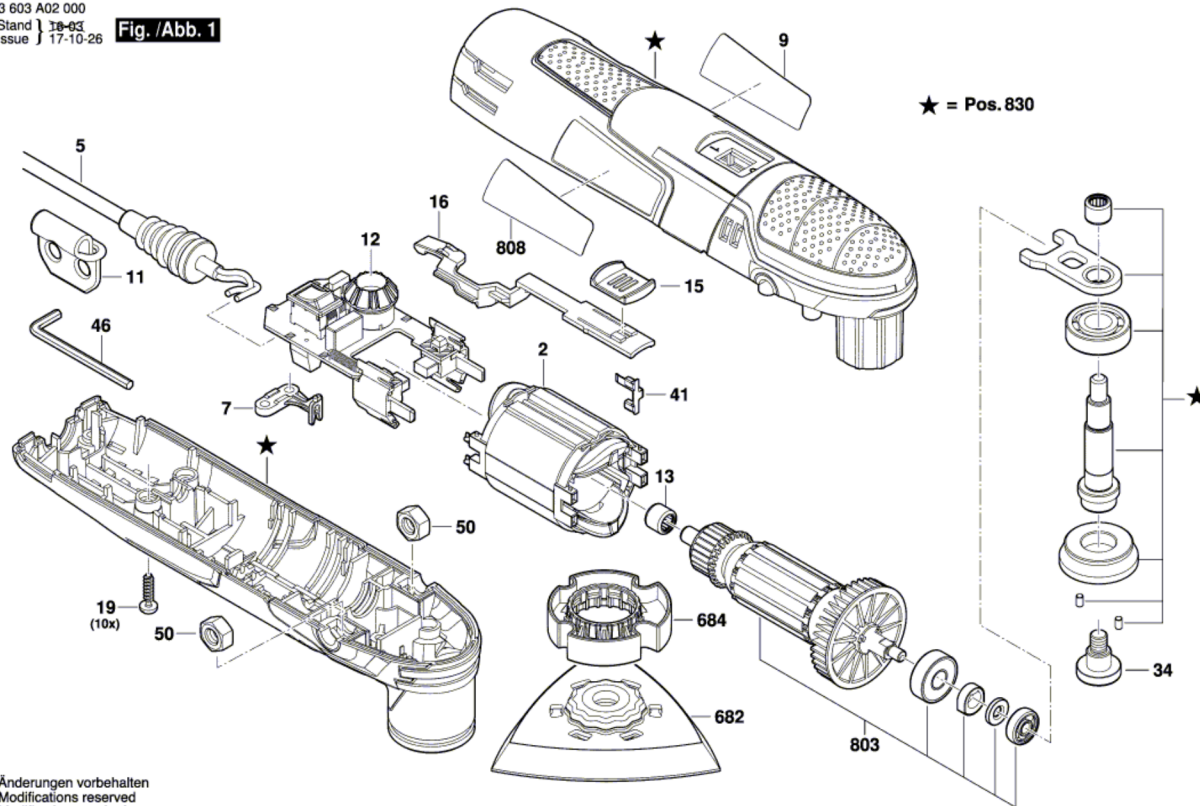

Änderungen vorbehalten
Modifications reserved
Modifications réservées
Salvo modificaciones