

0 601 621 703

Stand } 16-09  
Issue } 17-09-05

**Fig./Abb. 2**

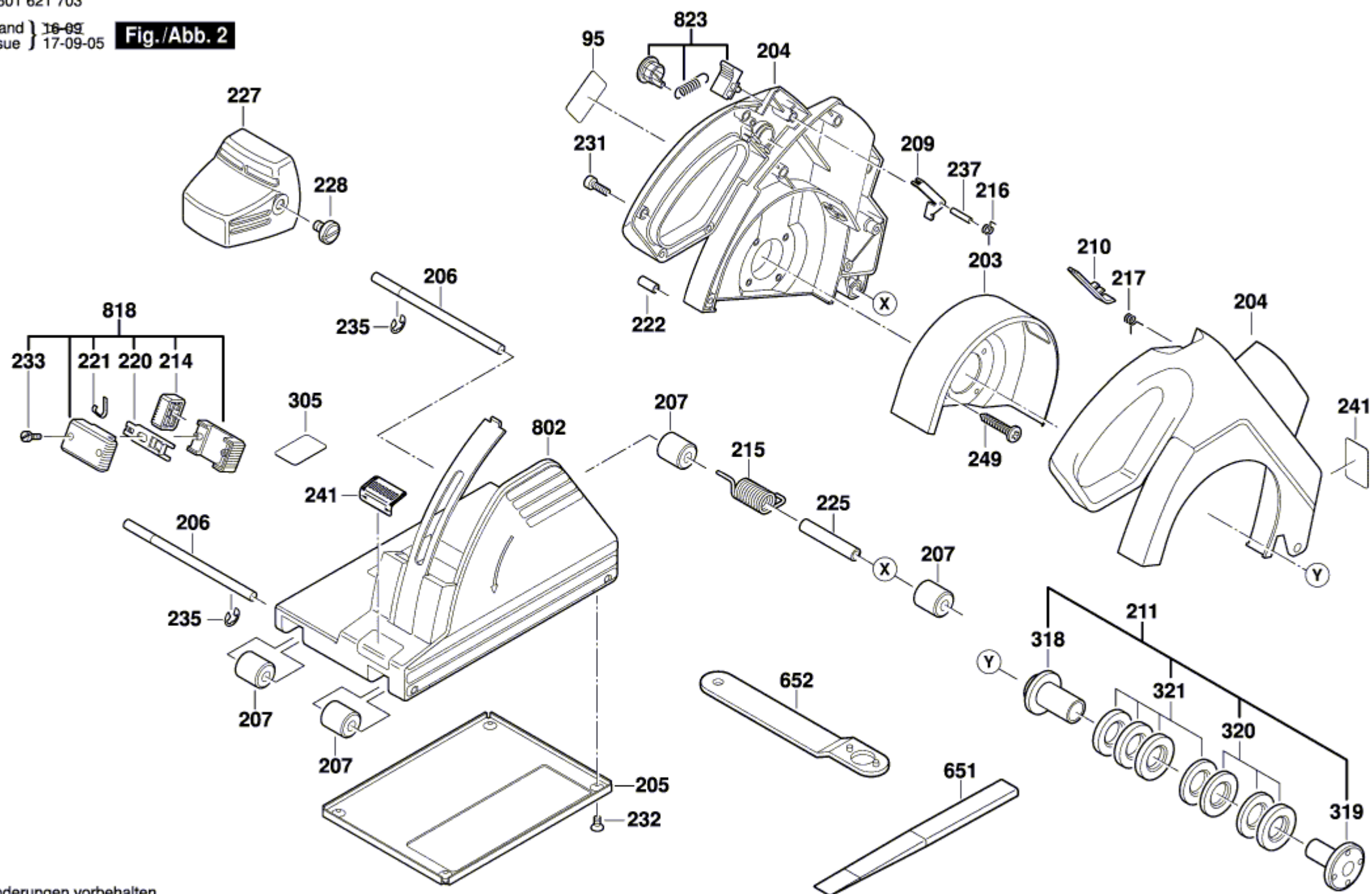

Änderungen vorbehalten  
Modifications reserved  
Modifications réservées  
Salvo modificaciones