

0 601 621 703

Stand | 18-09

Issue | 17-09-05

Fig./Abb. 2

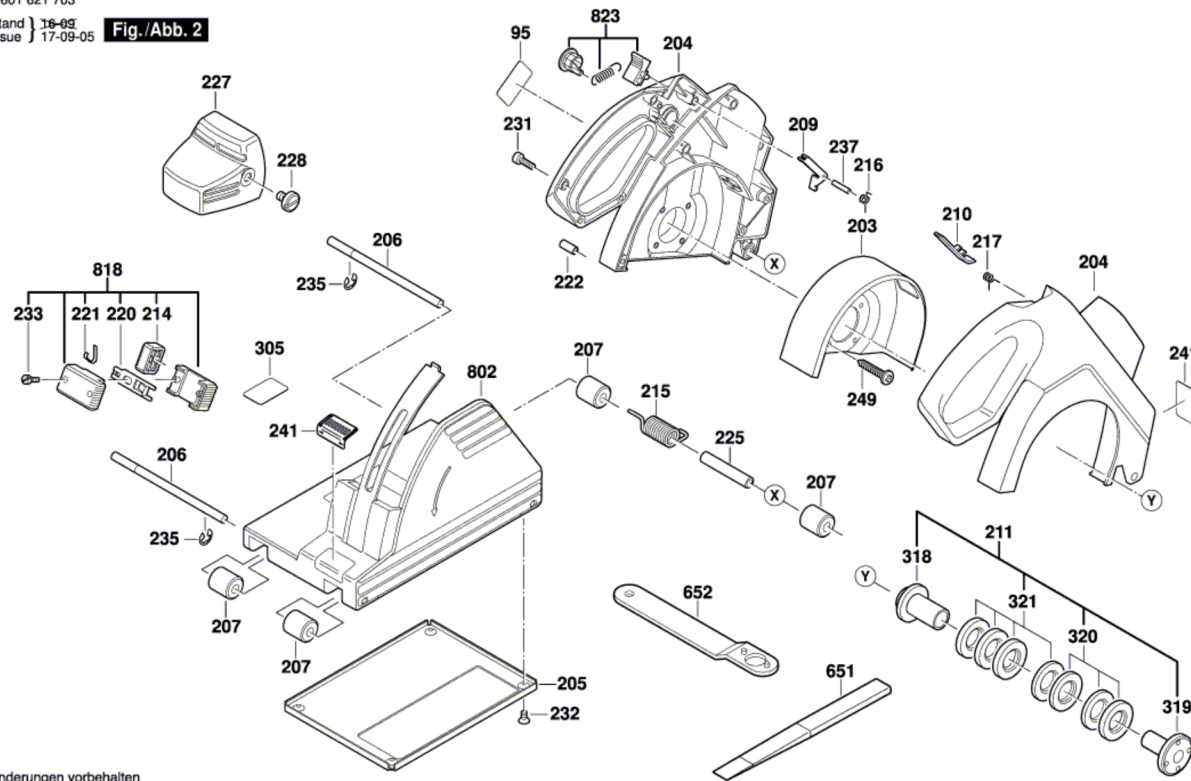

Änderungen vorbehalten
Modifications reserved
Modifications réservées
Salvo modificaciones