

0 611 254 803

Issue } 14-03-27
Stand }

Fig./Abb. 2

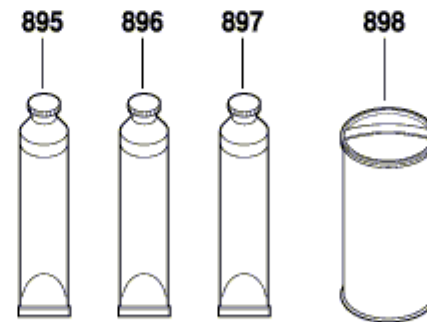
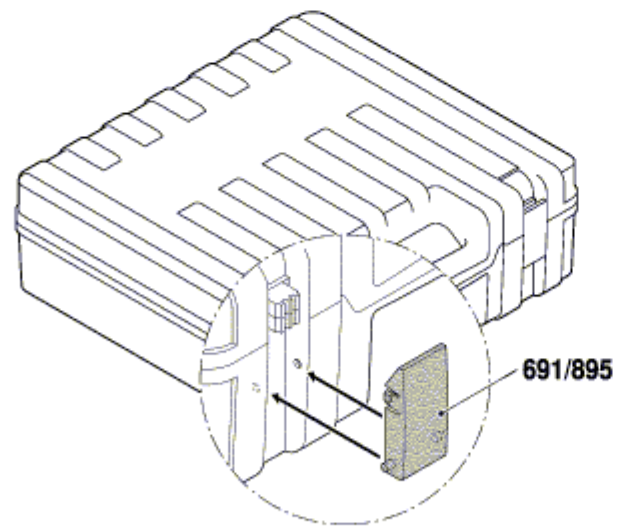
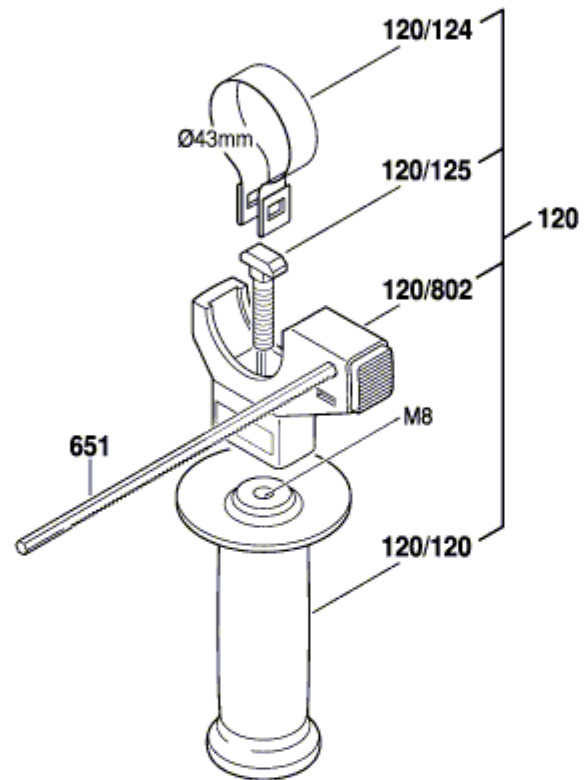

Modifications reserved
Änderungen vorbehalten
Modifications réservées
Salvo modificaciones