

3 611 967 200  
Issue | 14-03-27  
Stand | **Fig./Abb. 2**

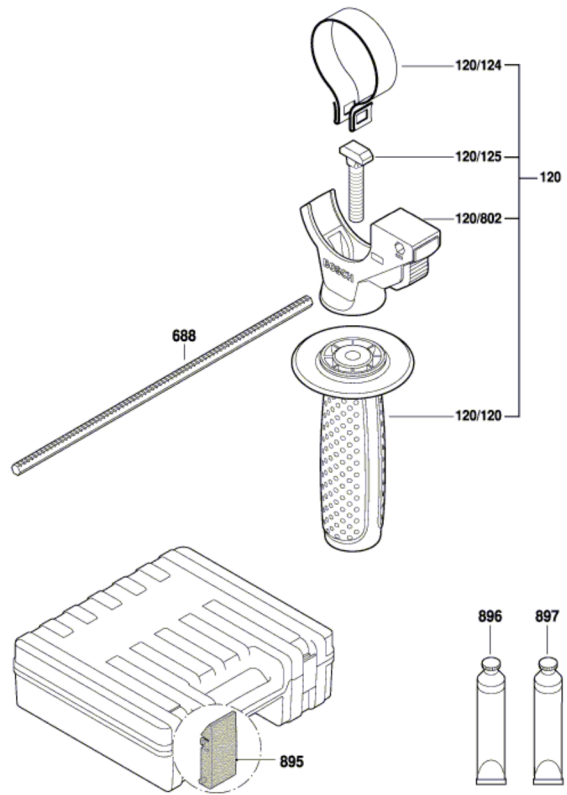

Modifications reserved  
Änderungen vorbehalten  
Modifications réservées  
Salvo modificaciones