

3 603 A00 500
Stand } 14-02
Issue } 14-08-13

Fig./Abb. 1

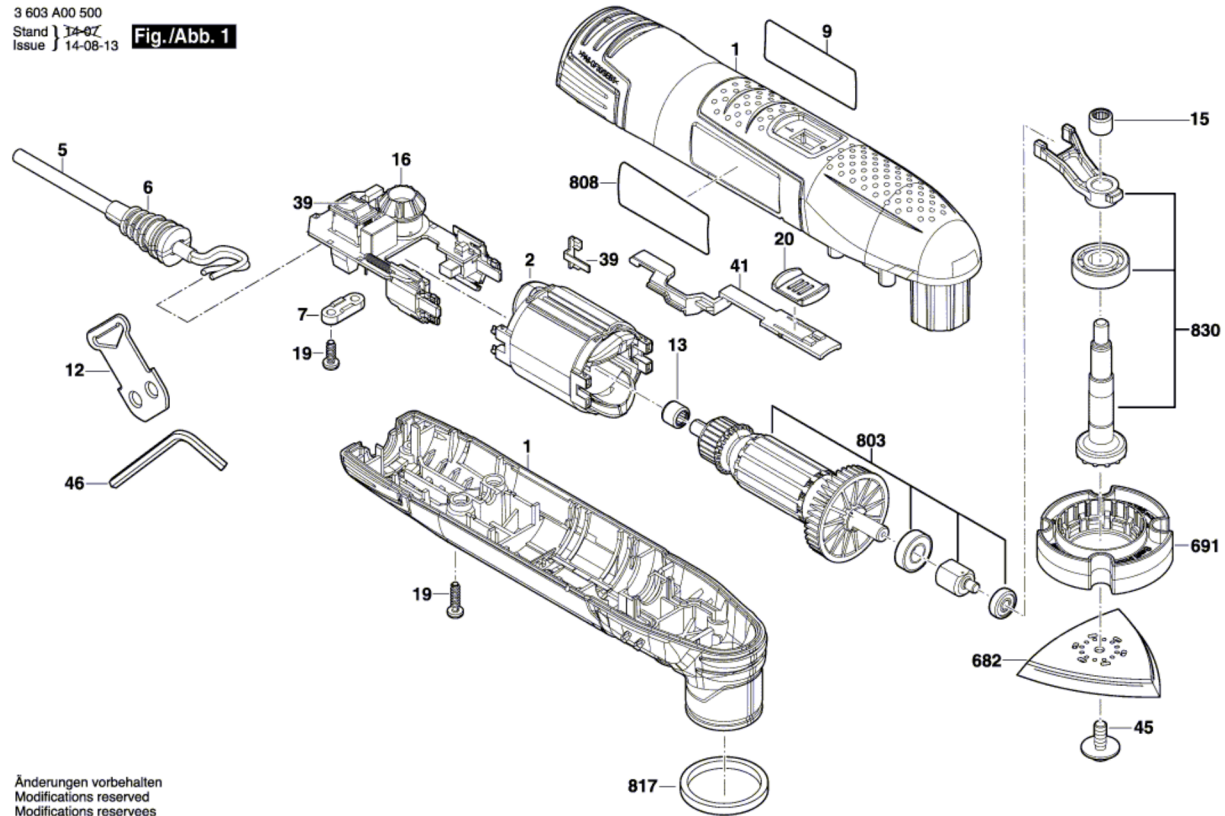

Änderungen vorbehalten
Modifications reserved
Modifications reserves
Salvo modificaciones