

0 611 254 703

Issue } 14-03-27
Stand } **Fig./Abb. 2**

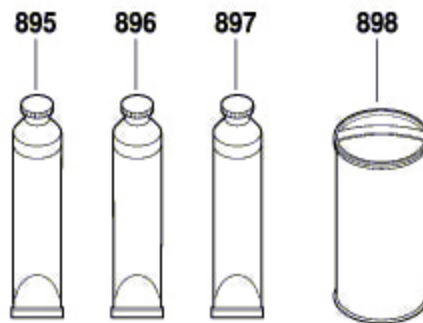
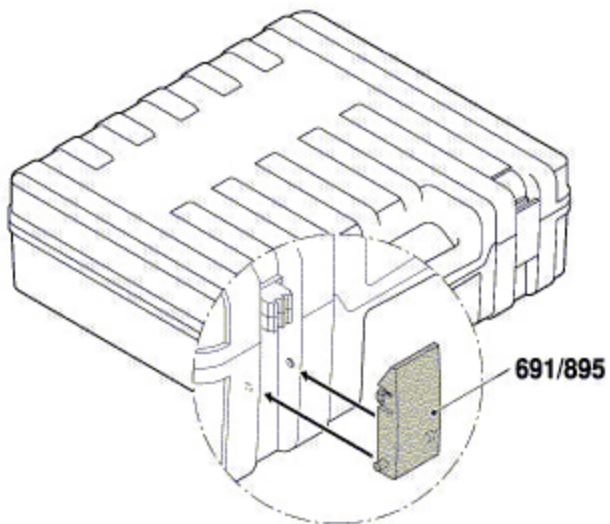
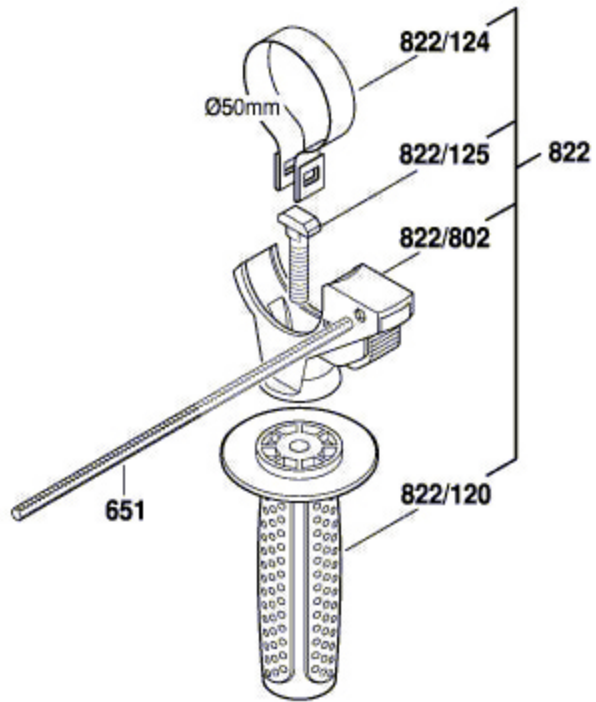

Modifications reserved
Änderungen vorbehalten
Modifications réservées
Salvo modificaciones