

3 601 G96 200

Stand } 12-07-26 **Fig./Abb. 2**
Issue }

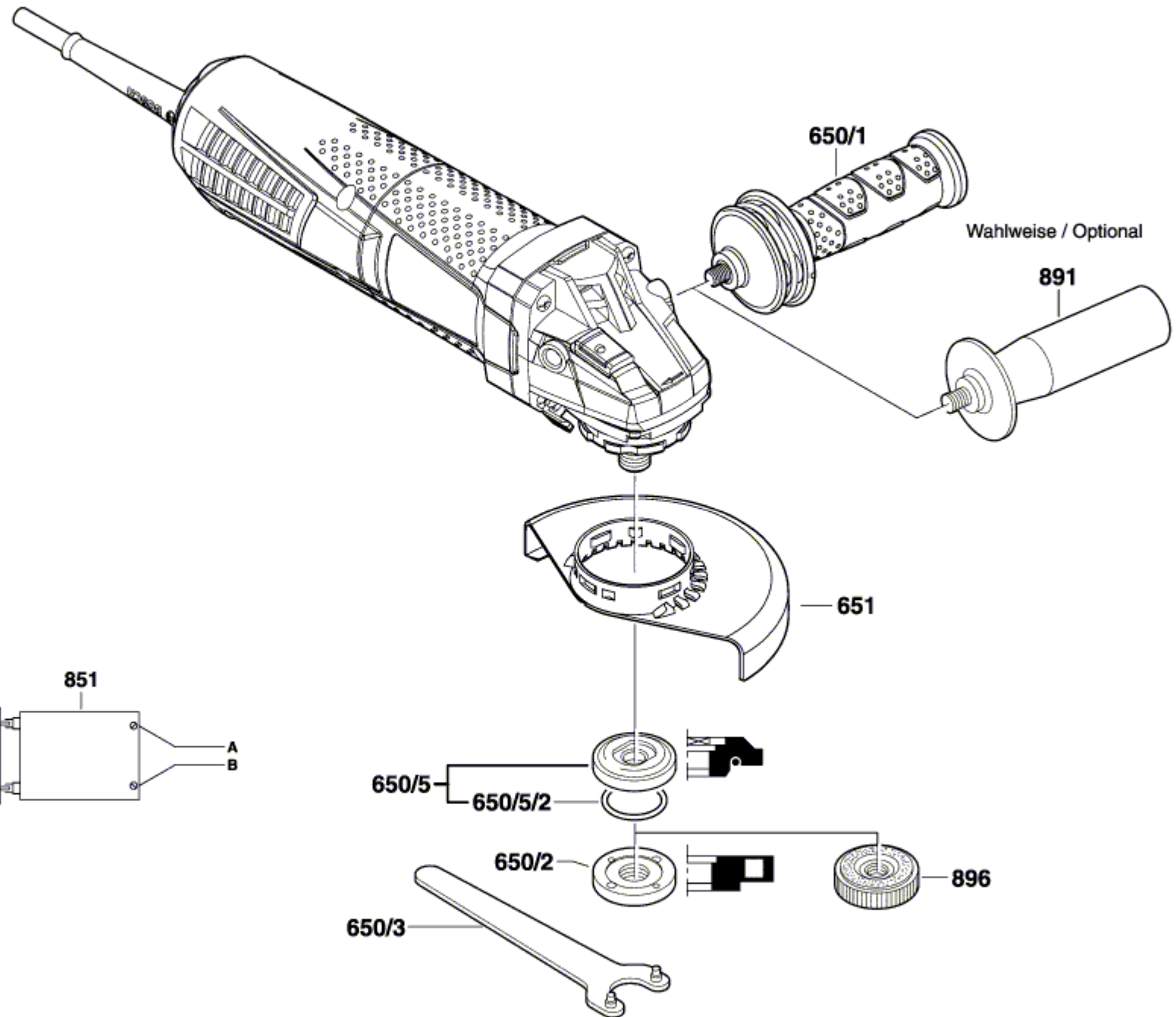

Änderungen vorbehalten
Modifications reserved
Modifications reserves
Salvo modificaciones