

3 601 G95 000

Stand } 11-09  
Issue } 14-03-27

**Fig./Abb. 2**

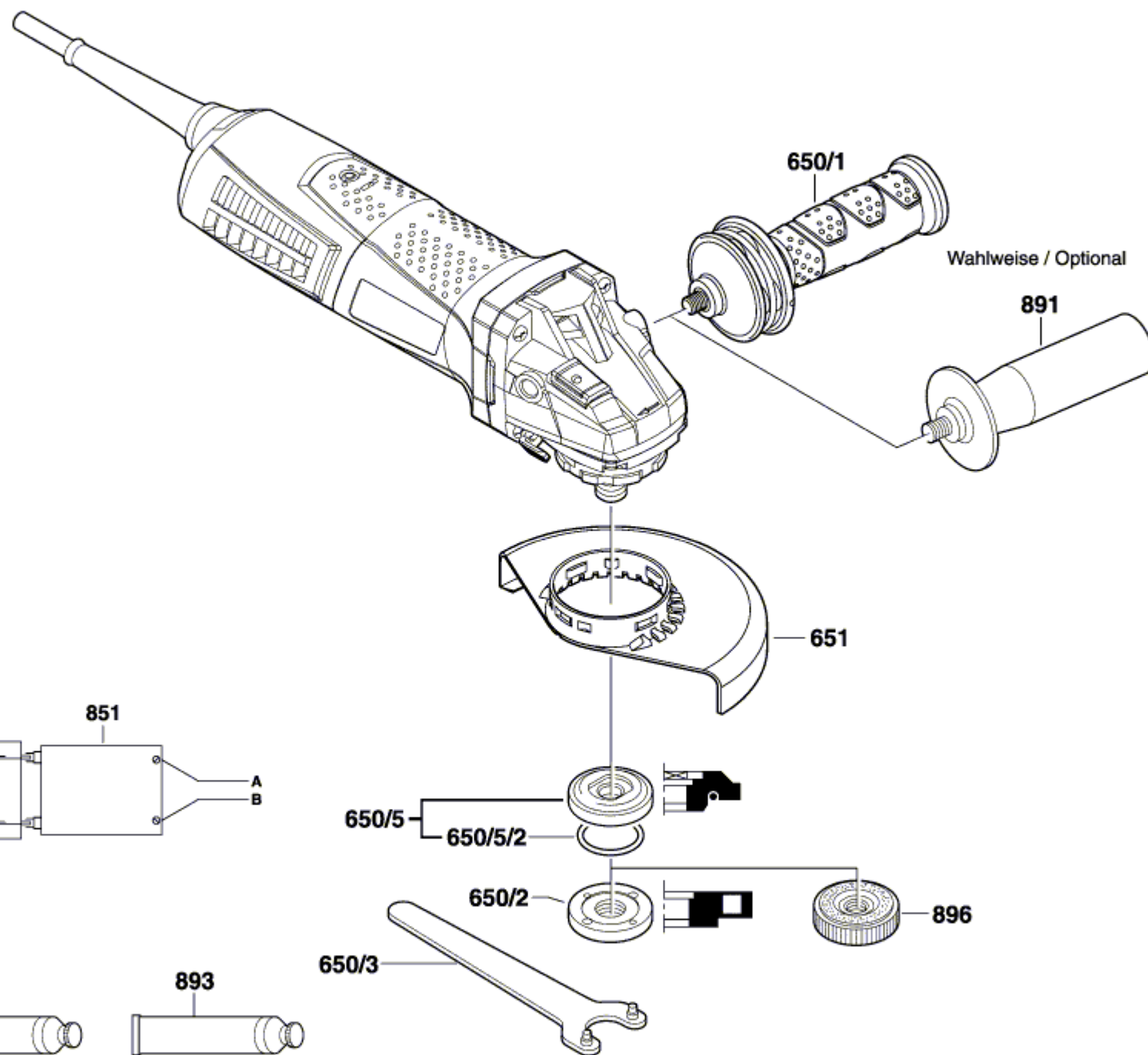

Änderungen vorbehalten  
Modifications reserved  
Modifications reserves  
Salvo modificaciones