

3 603 B44 401

Issue } 14-02-17
Stand } **Fig./Abb. 2**

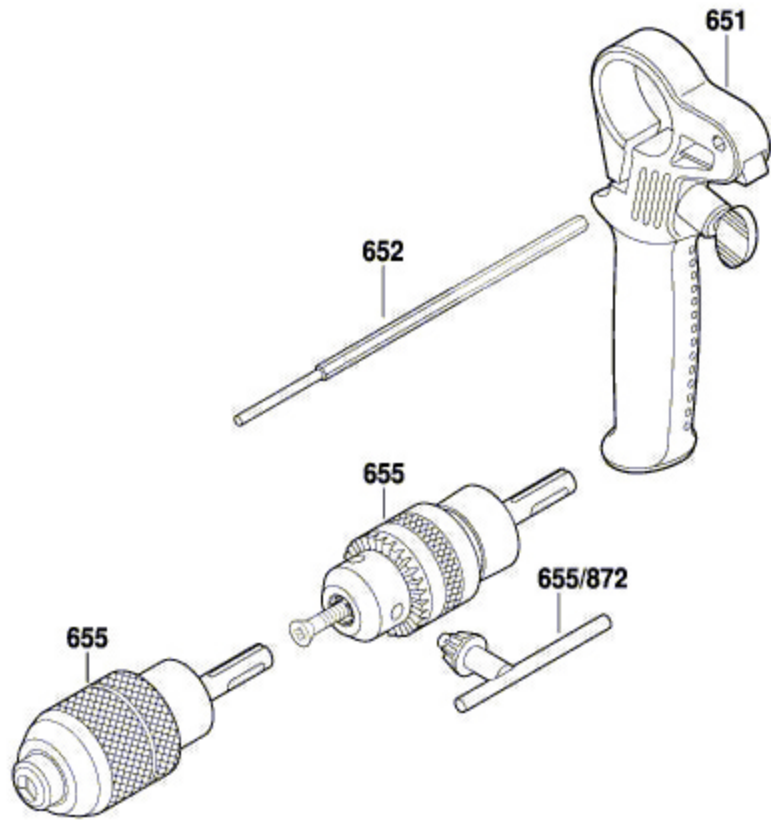

Modifications reserved
Änderungen vorbehalten
Modifications réservées
Salvo modificaciones