

F 015 104 801
Stand } 10-04
Issue } 15-02-04

Fig. /Abb. 1

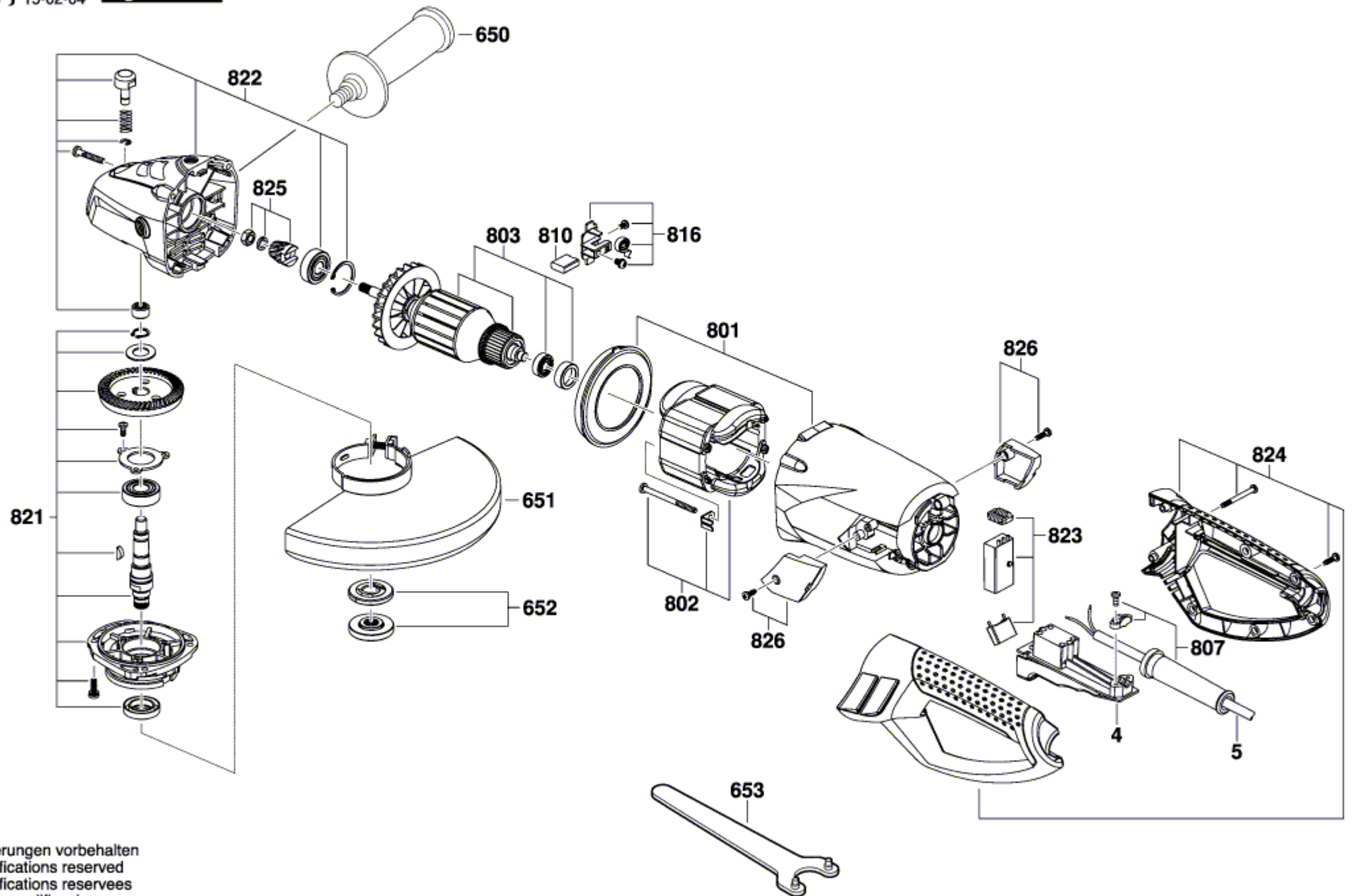

Änderungen vorbehalten
Modifications reserved
Modifications reserves
Salvo modificaciones