

0 611 253 703

Issue } 14-10-29
Stand }

Fig./Abb. 2

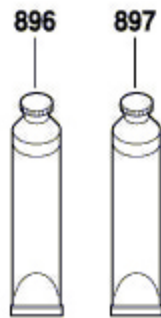
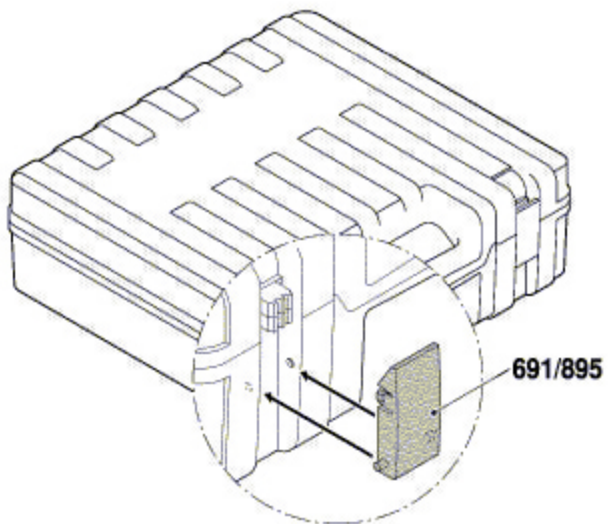
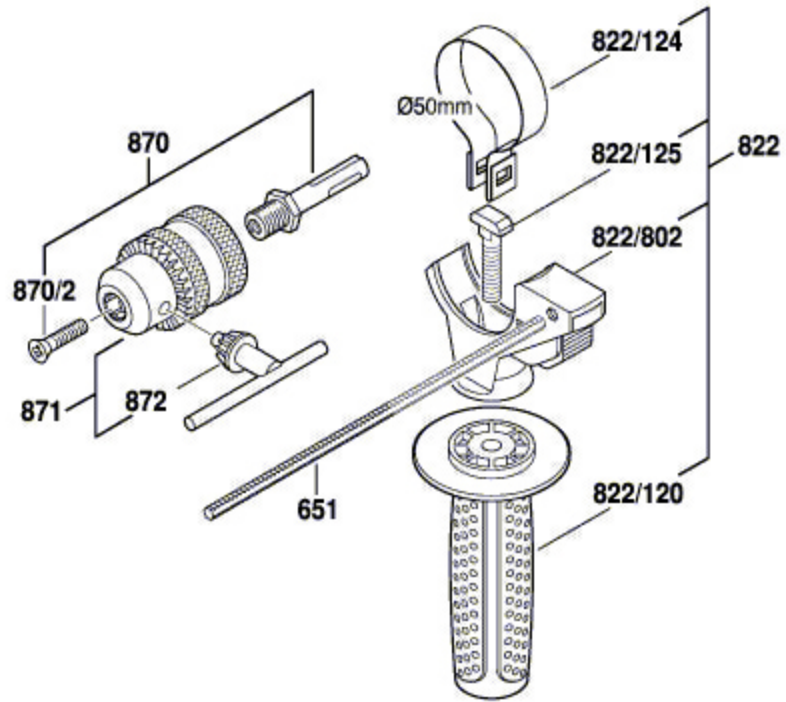

Modifications reserved
Änderungen vorbehalten
Modifications réservées
Salvo modificaciones