

3 603 C44 301

Issue } 11-09-14
Stand } **Fig./Abb. 2**

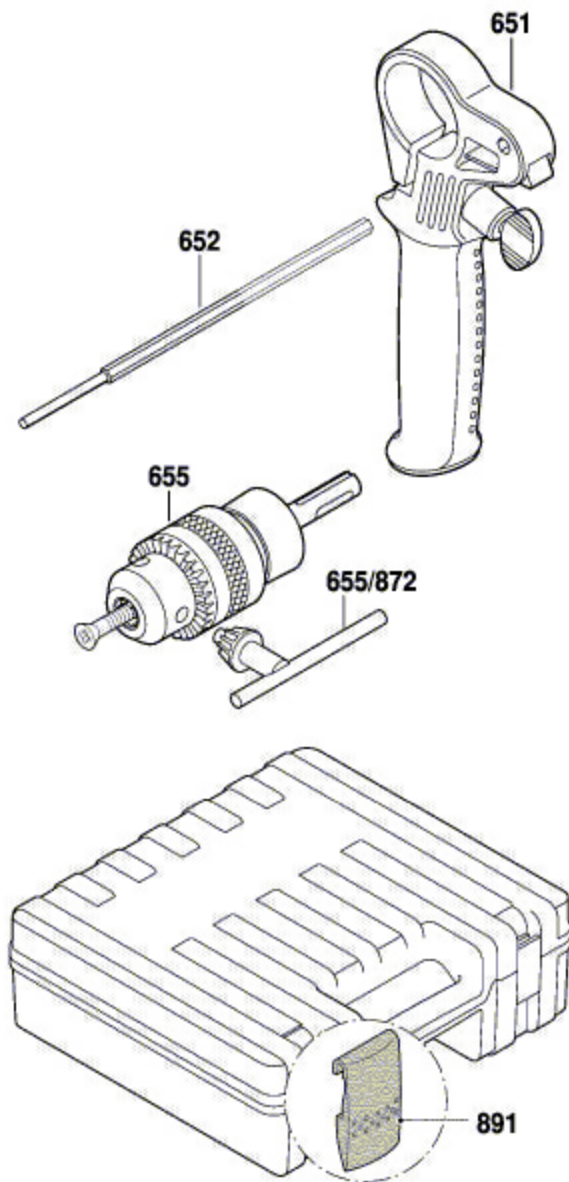

Modifications reserved
Änderungen vorbehalten
Modifications réservées
Salvo modificaciones