

0 601 357 103 / 803

Stand } 95-1
Issue } 02-04-25

Fig./Abb. 2

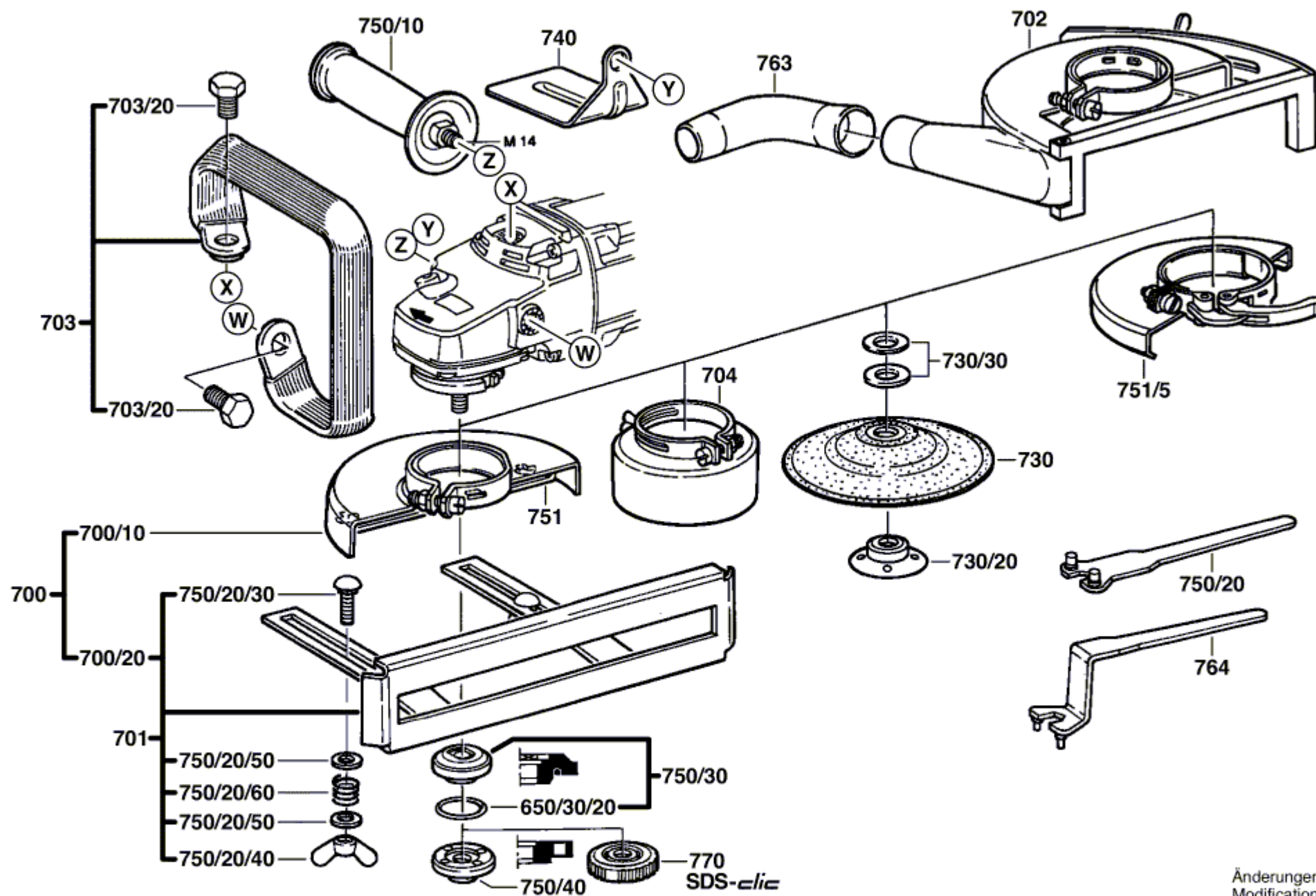

Änderungen vorbehalten
Modifications reserved
Modificaciones reservées
Salvo modificaciones